



**CLEAN DEVELOPMENT MECHANISM  
PROJECT DESIGN DOCUMENT FORM (CDM-PDD)  
Version 03 - in effect as of: 28 July 2006**

**CONTENTS**

- A. General description of project activity
- B. Application of a baseline and monitoring methodology.
- C. Duration of the project activity / crediting period
- D. Environmental impacts
- E. Stakeholders' comments

**Annexes**

- Annex 1: Contact information on participants in the project activity
- Annex 2: Information regarding public funding
- Annex 3: Baseline information
- Annex 4: Monitoring plan

**SECTION A. General description of project activity****A.1 Title of the project activity:**

&gt;&gt;

Yunan Jiehua N<sub>2</sub>O Abatement Project  
Version 02  
April 25, 2007

**A.2. Description of the project activity:**

&gt;&gt;

The proposed project, Yunan Jiehua N<sub>2</sub>O Abatement Project (hereafter, the Project), is developed by the Yunan Jiehua Group and EcoSecurities (hereafter referred to as the Project Developer). The purpose of the Project is to reduce the current levels of N<sub>2</sub>O emissions at the Project Developer's fertilizer plant during the production of nitric acid (HNO<sub>3</sub>).

Nitrous Oxide (N<sub>2</sub>O) is an undesired by-product emitted from the production of nitric acid (HNO<sub>3</sub>), which is formed during the catalytic oxidation of Ammonia. As N<sub>2</sub>O itself does not have any economic value or toxicity, it has been directly released into the atmosphere from nitric acid production plants without any treatment. The production process of nitric acid typically generates N<sub>2</sub>O quantities of 2-19 kg per tonne of pure anhydrous nitric acid (100%).<sup>1</sup> However, it is recognised as a potent greenhouse gas with a Global Warming Potential (GWP) of 310 compared to carbon dioxide (CO<sub>2</sub>), which is responsible for approximately 6% of the greenhouse effect at present<sup>2</sup>.

The Project will use the secondary N<sub>2</sub>O abatement catalyst technology which involves the installation of a secondary catalyst in the burner basket. The secondary catalyst will be located beneath the ammonia oxidation catalyst gauzes, through the secondary catalyst N<sub>2</sub>O will be converted into Nitrogen (N<sub>2</sub>) and Oxygen (O<sub>2</sub>) which have no adverse environmental or human health impacts.

The Project will produce environmental and economic benefits, which will contribute to the sustainable development of the Host Country. The specific sustainable development benefits of the Project are as follows:

- The installation of a N<sub>2</sub>O abatement technology, including a novel N<sub>2</sub>O abatement catalyst and monitoring system/equipment, which will represent a technology transfer to the Host Country. Furthermore, the local plant staff will be trained to operate this new equipment;
- The awareness of local residents regarding environmental protection will enhance through a series of training sessions to both plant staff and local people;
- The applied monitoring system for N<sub>2</sub>O emissions will follow the European Standard EN 14181, which is not only new for the Project Developer and for the Host Country, but also novel in Europe. By following the quality assurance of the automated measuring systems, the local

---

<sup>1</sup> Good Practice guide and uncertainty Management National Greenhouse Inventories by the International Panel on Climate Change (IPCC), 2000.

<sup>2</sup> [http://www.yptenc.org.uk/docs/factsheets/env\\_facts/glob\\_warm.html](http://www.yptenc.org.uk/docs/factsheets/env_facts/glob_warm.html)



employees will build capacity in these quality management techniques that are not yet widely spread in the Host Country;

- The commissioning and operation of monitoring equipments and catalyst will contribute to the creation of the technical and organisational capacity of domestic contractors.

### A.3. Project participants:

>>

| Name of party involved (*)<br>((host) indicates a host party) | Private and/or public<br>entity(ies)<br>Project participants (*)<br>(as applicable) | Kindly indicate if the Party<br>involved wishes to be<br>considered as project<br>participant<br>(Yes/No) |
|---|---|---|
| P. R. China (Host)  | Yunan Jiehua Group (public<br>entity)   | No  |
| United Kingdom of Great Britain<br>and Northern Ireland       | EcoSecurities Group PLC   | No  |

(\*) In accordance with the CDM modalities and procedures, at the time of making the CDM-PDD public at the stage of validation, a Party (country) involved may or may not have provided its approval. At the time requesting registration, the approval by the Party(ies) involved is required.

Further contact information of project participants is provided in Annex 1.

### A.4. Technical description of the project activity:

#### A.4.1. Location of the project activity:

>>

##### A.4.1.1. Host Party(ies):

>>

The People's Republic of China (the "Host Country")

##### A.4.1.2. Region/State/Province etc.:

>>

Yunan

##### A.4.1.3. City/Town/Community etc:

>>

Kaiyuan city

##### A.4.1.4. Detail of physical location, including information allowing the unique identification of this project activity (maximum one page):

>>

The Project is located near Kaiyuan city in Yunnan Province, 228 km away from Kuming City. The coordinates of the project are: 23°42'40.00"N latitude, 103°14'46.00"E longitude. A regional map is shown below:

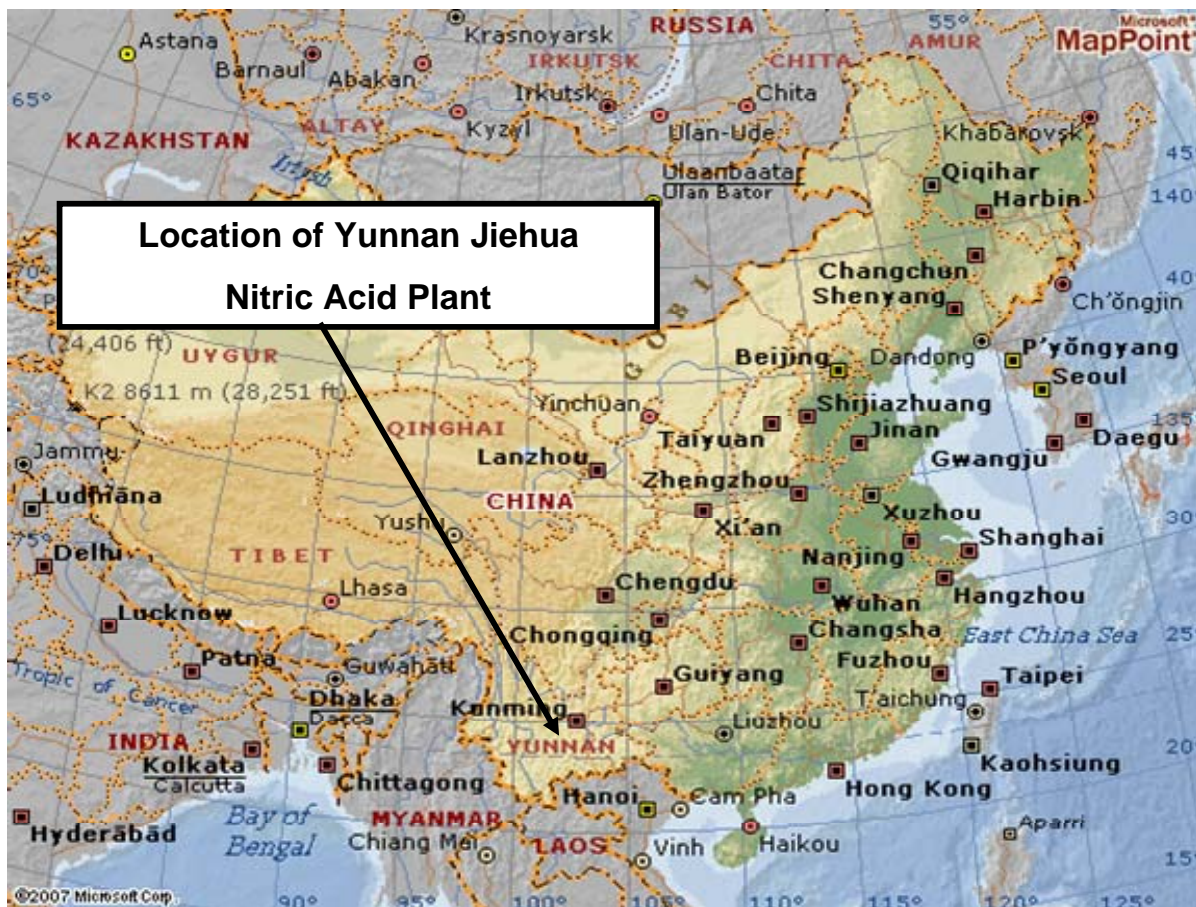
**A.4.2. Category(ies) of project activity:**

&gt;&gt;

Sectoral Scope 5: Chemical Industry

**A.4.3. Technology to be employed by the project activity:**

&gt;&gt;

The Project will use the secondary  $N_2O$  abatement catalyst technology by which nitrous oxide ( $N_2O$ ) will be converted into Nitrogen ( $N_2$ ) and Oxygen ( $O_2$ ) at high temperature.

**Brief introduction of nitric acid production**

As shown in Figure 1, the process of nitric acid production involves three steps:

1. Oxidation of ammonia ( $NH_3$ ) in a reactor (ammonia burner)
2. Oxidation of nitric oxide (NO) into nitrogen dioxide ( $N_2O$ )
3. Nitric acid formation by absorption of nitrogen dioxide in demineralised water.

A brief introduction of these three process steps are described in the figure below:

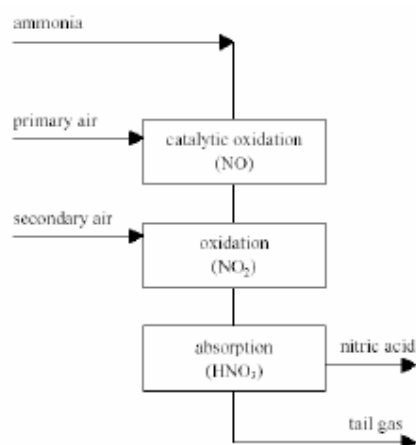
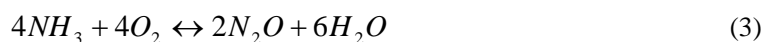

Figure 1. Nitric Acid Production Process

### Oxidation of ammonia

In the first step of this process evaporated ammonia is mixed with purified air in the ammonia oxidation reactor with an ammonia to air ratio of 10% by volume. The mixed gas is then led across a special catalyst (Pt-Rh) in the form of layers of precious metal gauze, where the following chemical reactions (1) to (3) occur simultaneously<sup>3</sup>.



Nitric oxide (NO) as shown in equation (1) is the desired gas in this process step. Equations (2) and (3) show the undesired side reactions with the nitrous oxide, nitrogen and water products.

### Oxidation of nitric oxide

The gases formed in the reactions above are cooled down. During the condensation weak nitric acid solution is formed, and is separated and sent to the absorption tower. The nitrous oxide gas is mixed with NO<sub>x</sub>-bearing secondary air from the bleaching section. In the oxidation section of the absorption column, the nitric oxide gas reacts non-catalytically with oxygen, and nitrogen dioxide (NO<sub>2</sub>) is formed as described in equation (4):



---

<sup>3</sup> International Fertilizer Industry Association (Technical Report No.26 Part 1), "Mineral Fertilizer Production and the Environment. Part 1. The Fertilizer Industry's Manufacturing Processes and Environmental Issues." pp. 18-21, 1998.



### Absorption of nitrogen dioxide

In this step, demineralised water or steam condensate is added at the top of the absorption column. The weak nitric acid solution produced in the condenser is also pumped into the absorption column. The nitrogen dioxide in the absorption column is mixed in a counter-current flow with water. The nitric acid is formed by following the equation (5):

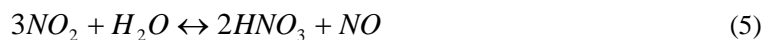

The nitric acid produced, which is rich in dissolved nitrogen oxides, is passed to a bleaching tower where it is mixed with a counter flow of air. By doing so the air and nitrogen oxides can be stripped out, then they leave the condenser and are used as secondary air to be recycled to the absorption section. The aqueous solution of nitric acid is at a concentration of approximately 50-55%, which is withdrawn from the bottom of the absorption tower, is the final product in the nitric acid production plant. The nitric acid concentration is maintained by carrying out periodic strength analysis using a calibrated hydrometer and adjusting the water addition into the absorption tower accordingly.

The tail gas which has not been absorbed in the nitric acid solution leaves the absorption column at the top. The temperature of the gas is about 20-30 °C, which is then heated in the heat recovery section. Currently no SCR (Selective Catalytic Reduction) NOx abatement system is in place.. The resulting expanded tail gas is directly vented through the stack into the atmosphere.

### **Description of the abatement technology to be employed**

The abatement technology to be employed is called the secondary N<sub>2</sub>O abatement catalyst technology. The project activity involves the installation of the secondary abatement catalyst inside the ammonia burner beneath the precious metal gauze pack and the catchment gauze, as shown in Figure 2. N<sub>2</sub>O is eliminated once it is formed in the burner. The de-N<sub>2</sub>O catalyst is selective and promotes the reaction described in equation (6).



The catalyst used for the proposed Project activity is a secondary N<sub>2</sub>O abatement catalysts. The catalyst is composed of the active components which are optimized for decomposing N<sub>2</sub>O to nitrogen and oxygen at the Ammonia burner at operating temperatures of 800-950 °C.

Figure 3 shows the existing ammonia burner currently used at the plant. The de-N<sub>2</sub>O catalyst will be used in this reactor. The new catalyst does not have any effect on the present production. The catalyst will be installed in the burner basket in a flat, perfectly level, homogenous surface. The precious metal gauze pack and the catchment gauze are installed as normal on the top of the de-N<sub>2</sub>O catalyst. The installation can be done during a planned shut-down.

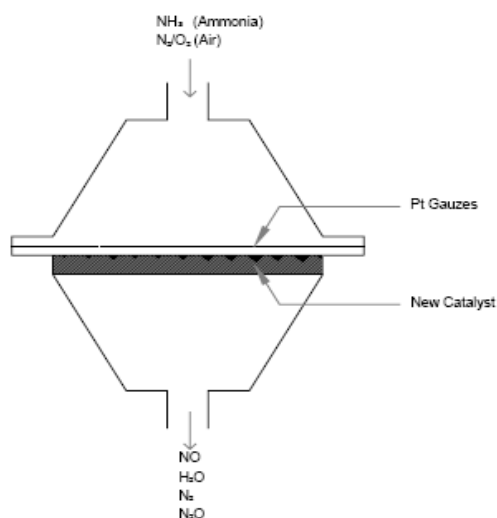

Figure 2. The ammonia burner with the installed de-N<sub>2</sub>O catalyst

Figure 3. The existing ammonia burner at the plant

There is no leakage generated by the project activity due to the fact that the installation of the secondary catalyst does not have an impact on the process of the production other than the level of N<sub>2</sub>O emission.

### Plant information

The existing production unit at the Project Developer's nitric acid plant is a type of dual pressure, medium plant which began operations in 1999. Some key information about this plant is shown in Table 1.

Table 1. Key parameters of the production unit at the nitric acid plant

|  |                                 |
|--|---------------------------------|
| Design capacity                          | 272 100% tHNO <sub>3</sub> /day |
| Reactor pressure                         | Dual pressure/medium            |
| Number of burners                        | 1                               |
| Production in 2005, (tHNO <sub>3</sub> ) | 50057                           |
| Production in 2004, (tHNO <sub>3</sub> ) | 50057                           |
| Production in 2003, (tHNO <sub>3</sub> ) | 50057                           |

**A.4.4 Estimated amount of emission reductions over the chosen crediting period:**

&gt;&gt;

The annual production of HNO<sub>3</sub> nitric acid is expected to be 63,360 tonne per year for the next seven year. The abatement efficiency of the N<sub>2</sub>O abatement catalyst is expected to be 80%. The estimated emission reduction is expected to be 108,996 tonnes of CO<sub>2</sub> equivalent per year.

Estimated emission reduction from the project activity over the first crediting period

| Years   | Annual estimation of emission reductions<br>in tonnes of CO <sub>2</sub> e |
|---|--|
| 2008  | 108996   |
| 2009  | 108996   |
| 2010  | 108996   |
| 2011  | 108996   |
| 2012  | 108996   |
| 2013  | 108996   |
| 2014  | 108996   |
| Total estimated reductions<br>(tonnes of CO <sub>2</sub> e)                                       | 762972   |
| Total number of years in the first crediting<br>period  | 7 (seven)  |
| Annual average over the crediting period of<br>estimated reductions (tonnes of CO <sub>2</sub> e) | 108996   |

**A.4.5. Public funding of the project activity:**

&gt;&gt;

The Project will not receive any public funding from Parties included in Annex I of the UNFCCC.





**SECTION B. Application of a baseline and monitoring methodology****B.1. Title and reference of the approved baseline and monitoring methodology applied to the project activity:**

&gt;&gt;

AM0034 VERSION 02 “Catalytic reduction of N<sub>2</sub>O inside the ammonia burner of nitric acid plants”.

**B.2 Justification of the choice of the methodology and why it is applicable to the project activity:**

&gt;&gt;

The chosen Baseline Methodology is applicable to the Project at the Project Developer’s nitric acid plant. The justification is as follows:

- The project activity involves the installation of a secondary N<sub>2</sub>O abatement catalyst inside the ammonia burner of a nitric acid plant, underneath the precious metal gauze pack.
- The proposed existing nitric acid production facility was erected and began operations in 1999 and has been operating since then;
- No N<sub>2</sub>O abatement technology is currently installed in the proposed nitric acid plant;
- The project activity will not affect the level of nitric acid production at the existing facility;
- There are currently no regulatory requirements or incentives to reduce levels of N<sub>2</sub>O emissions from nitric acid plants in the Host Country;
- There is no Selective Catalytic Reduction (SCR) DeNO<sub>x</sub> unit installed at the existing facility,;
- The project activity will not cause any increase of NO<sub>x</sub> emissions;
- There is no additional energy consumption, raw material consumption (ammonia, air, water) caused by the project activity. In addition, there is no leakage generated by the proposed Project Activity. Thus, the Project will not lead to any additional emissions of greenhouse gases, either directly or indirectly;
- The monitoring system will be installed prior to the installation of the secondary catalyst and monitoring will be carried out for one complete campaign in accordance with EN 14181. The Monitoring will continue after the installation of the secondary catalyst throughout the chosen crediting period of the project activity.

**B.3. Description of the sources and gases included in the project boundary**

&gt;&gt;

The Figure 4 below demonstrates the project boundary of the nitric acid plant involved in the project activity. The spatial extent of the project boundary covers the facility and equipments for the complete nitric acid production process from the inlet to the ammonia burner to the stack, all compressors and tail gas expander turbines are also included. Table 2 further shows the overview of emission sources included or excluded from the project boundary. According to this table, the only greenhouse gas to be included in the project boundary is the N<sub>2</sub>O contained in the tail gas.

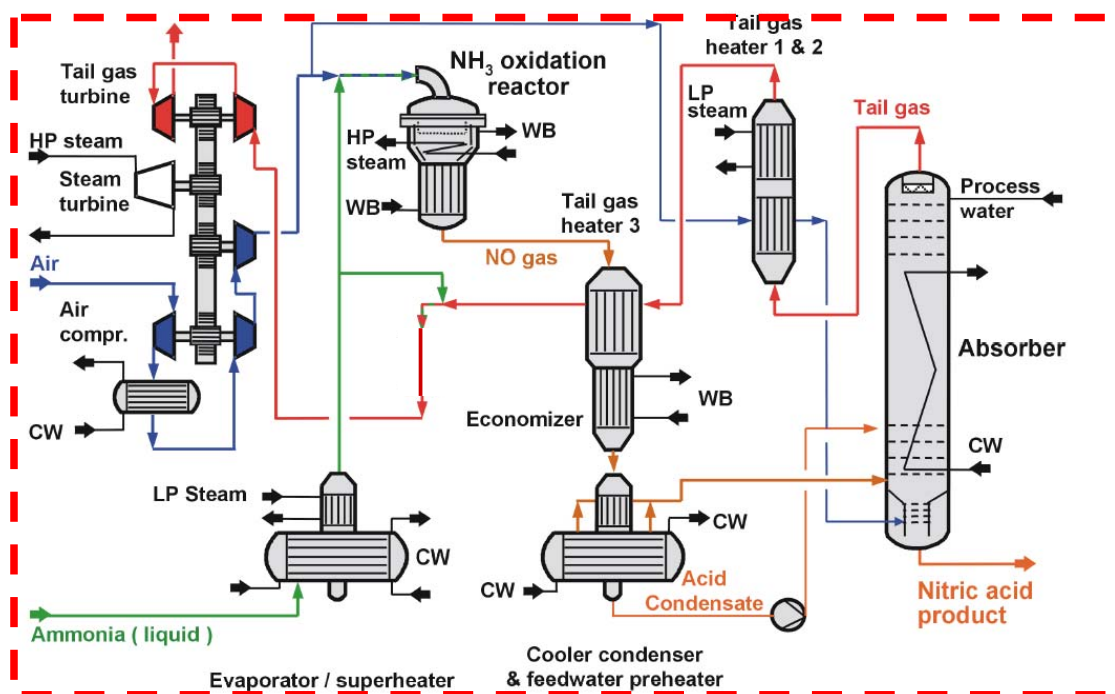

Figure 4. General nitric acid production process and the project boundary

Table 2. Overview of emission sources included or excluded from the project boundary

|                  | Source   | Gas              | Included? | Justification / Explanation  |
|------------------|--|------------------|-----------|--|
| Baseline         | Nitric Acid Plant<br>(Burner Inlet to Stack)   | CO <sub>2</sub>  | Excluded  | The project does not lead to any change in CO <sub>2</sub> or CH <sub>4</sub> emission, therefore, they are not included.  |
|                  |  | CH <sub>4</sub>  | Excluded  |  |
|                  |  | N <sub>2</sub> O | Included  |  |
| Project Activity | Nitric Acid Plant<br>(Burner Inlet to Stack)   | CO <sub>2</sub>  | Excluded  | The project does not lead to any change in CO <sub>2</sub> or CH <sub>4</sub> emission, therefore, they are not included. N <sub>2</sub> O emissions at the stack are included as the project activity aims for its reduction at the burner. |
|                  |  | CH <sub>4</sub>  | Excluded  |  |
|                  |  | N <sub>2</sub> O | Included  |  |
|                  | Leakage emissions from production, transport, operation and decommissioning of the catalyst. | CO <sub>2</sub>  | Excluded  | No leakage emissions are expected.   |
|                  |  | CH <sub>4</sub>  | Excluded  |  |
|                  |  | N <sub>2</sub> O | Excluded  |  |

**B.4. Description of how the baseline scenario is identified and description of the identified baseline scenario:**

>>



As per the methodology AM0034 VERSION 02, the baseline scenario is identified using the procedure for *Identification of the baseline scenario described in the approved methodology AM0028 Version 04 “Catalytic N<sub>2</sub>O destruction in the tail gas of Nitric Acid Plants”*. The determination of the baseline scenario consists of steps 1 to 5 below.

**Step 1: Identify technically feasible baseline scenario alternatives to the project activity:**

According to the approved methodology AM0028 Version 04, the baseline scenario alternatives should include all technically feasible options which are realistic and credible.

**Step 1a:** The alternatives to the baseline scenario include all possible options that are technically feasible to handle N<sub>2</sub>O emissions including the following:

1. Continuation of *status quo*. The continuation of the current situation, where there will be no installation of technology for the abatement of N<sub>2</sub>O.
2. Alternative uses of N<sub>2</sub>O, such as:
  - a. Recycling of N<sub>2</sub>O as a feedstock for the plant;
  - b. The use of N<sub>2</sub>O for an external purpose.
3. Installation of a Non-Selective Catalytic Reduction (NSCR) DeNO<sub>x</sub> unit.
4. The installation of a N<sub>2</sub>O abatement technology, including:
  - a. Primary abatement technology involving the alternation of the physical properties of the precious metal gauzes which can result in the reduction of N<sub>2</sub>O emissions.
  - b. Secondary abatement technology including the insertion of an additional catalyst underneath the precious metal gauzes inside the ammonia burner (the proposed project activity not implemented as a CDM project).
  - c. Tertiary abatement technology requiring the erection of a dedicated catalyst chamber and building downstream of the ammonia burner.

Option 4.b. represents the proposed project activity not implemented as a CDM project.

**Step 1b:** In addition to the baseline scenario all possible alternatives of step 1a that are technically feasible to handle NO<sub>x</sub> emissions should be considered since some NO<sub>x</sub> technical solutions could also have an effect on N<sub>2</sub>O emission reduction. The options include

5. The continuation of the current situation, whether a de-NO<sub>x</sub>-unit is installed or not;
6. Installation of a new Selective Catalytic Reduction (SCR) de-NO<sub>x</sub> unit;
7. Installation of a new Non-Selective Catalytic Reduction (NSCR) de-NO<sub>x</sub> unit;
8. Installation of a new tertiary measure that combines NO<sub>x</sub> and N<sub>2</sub>O emission reduction.

**Step 2: Eliminate baseline alternatives that do not comply with legal or regulatory requirements:**

All alternatives comply with applicable laws and regulations. There are no national regulations or legal obligations in the Host Country concerning specifically N<sub>2</sub>O emission at the moment, and it is unlikely that any such limits on N<sub>2</sub>O emissions will be imposed in the near future.



The maximum permissible value of NO<sub>x</sub> emissions is 1400 mg/m<sup>3</sup> (ca. 700 ppm)<sup>4</sup> for nitric acid plants in the Host Country. The NO<sub>x</sub> emissions at the Project Developer's nitric acid production plant Yunan Jiehua Group are in compliance with this standard. Therefore, the continuation of the current situation is a valid baseline alternative.

All identified baseline scenario alternatives can not be eliminated in this step since they are all in compliance with legal and regulatory requirements.

### **Step 3: Eliminate baseline alternatives that face prohibitive barriers (barrier analysis):**

**Step 3a:** On the basis of the alternatives that are technically feasible and in compliance with all legal and regulatory requirements, the project participant should establish a complete list of barriers that would prevent alternatives to occur in the absence of CDM. The identified barriers are:

- Investment barriers, inter alia:
  - Debt funding is not available for this type of innovative project activity;
  - No access to international capital markets due to real or perceived risks associated with domestic or foreign direct investment in the Host Country.
- Technological barriers, inter alia:
  - Low efficiency of alternatives (e.g. low abatement rate of N<sub>2</sub>O destruction,);
  - Skilled and/or properly trained labour to operate and maintain the technology is not available yet, because currently no education / training institution in the Host Country undertakes the training needed for this technology;
  - Lack of infrastructure for implementation of the technology in the Host Country.
- Barriers due to prevailing practice, inter alia:
  - The project activity is the “first of its kind”: No project activity of this type is currently operational in the region and not even in the Host Country without Carbon finance. All projects similar to the proposed project activity are developed under the CDM.

A NSCR de-NO<sub>x</sub> unit will reduce N<sub>2</sub>O emissions as a side reaction to the NO<sub>x</sub>-reduction. Therefore, new NSCR installation can be considered as an alternative to N<sub>2</sub>O reduction technologies. However this technology will apply a reducing agent at temperatures above 300°C to destroy any forms of nitrogen oxides, i.e. NO<sub>x</sub>/N<sub>2</sub>O, therefore it requires significant energy input, resulting in additional greenhouse gas emissions and higher costs compared to Selective Catalytic Reduction (SCR)<sup>5</sup>. Thus it can not be considered as an attractive alternative to the proposed CDM activity.

Currently, the primary N<sub>2</sub>O abatement technology is still under development, the N<sub>2</sub>O removal efficiency is still not high enough. By comparison, secondary and tertiary abatement technologies are commercially available by reaching N<sub>2</sub>O abatement levels of about 80% or more. However, the tertiary abatement catalyst requires the use of additional hydrocarbons for catalytic reduction and heating of the tail gas ,

---

<sup>4</sup> The relevant Chinese law on NO<sub>x</sub> is the “Integrated emission standard of air pollutants GB16297-1996”.

<sup>5</sup> EPA (2001) U.S. Adipic Acid and Nitric Acid N<sub>2</sub>O Emissions 1990-2020: Inventories, Projections and Opportunities for Reductions (available for download at [http://www.epa.gov/nitrousoxide/pdfs/adipic\\_nitric\\_n2o.pdf](http://www.epa.gov/nitrousoxide/pdfs/adipic_nitric_n2o.pdf)).



which leads to higher operating costs as compared to the secondary abatement technology<sup>6</sup>, moreover, the dedicated catalytic reactor and associated structure is costly and requires a significant space.

As the nitrous oxide can not be used as a feedstock for nitric acid production, it is not recycled at any nitric acid plants in the Host Country or anywhere else. Therefore, the use of N<sub>2</sub>O for internal purpose can be eliminated from the baseline scenarios.

The use of N<sub>2</sub>O for external purpose is not technically feasible at the nitric acid facilities of the Project Developer's company due to the following two reasons: one is that the tail gas volume which needs to be treated is enormous compared to the amount of nitrous oxide that could be recovered; the other is that the N<sub>2</sub>O concentration in the tail gas is too low. There is no practical case to use N<sub>2</sub>O for external purposes at nitric acid plants in the Host Country or anywhere else in the world.

There are no major technical barriers faced by other baseline alternatives, however, they might require additional investments, which are discussed in Step 4.

#### **Step 4: Identify the most economically attractive baseline scenario alternative:**

The purpose of this step is to determine which of the remaining baseline alternatives, that are not prevented by any barrier, is the most financially attractive. The following steps are used to conduct the investment analysis:

##### **Sub-step 4a:** Determine appropriate analysis method:

The simple cost analysis (Option I) is chosen as the appropriate analysis method. This is due to the fact that there is no financial incentive for any of the remaining baseline alternatives apart from the CDM related income.

##### **Sub-step 4b:** Option I: Applying simple cost analysis:

Two baseline alternatives remain: the continuation of the current situation and the secondary abatement technology. The first one is the business-as-usual (BAU) scenario which means that no N<sub>2</sub>O abatement would occur; neither now nor in the near future. The second alternative would involve the additional investment and operating costs of the secondary abatement technology, without generating any economic benefits.

In terms of the identification of the baseline scenario, AM0028 version 4, states:

“If all alternatives do not generate any financial or economic benefits, then the least costly alternative among these alternative is pre-selected as the most plausible baseline scenario candidate.”

Hence the secondary abatement technology is not a plausible baseline scenario, and the continuation of *status quo* is the only feasible baseline scenario. This baseline meets all current applicable regulations in the Host Country, thus it does not require any additional investments or additional operation cost.

---

<sup>6</sup> Decomposition of N<sub>2</sub>O in the nitric acid industry, I. Melian-Cabrera, et al. Report number ECN-RX-05-080. Energy Research Center of The Netherlands, Petten, The Netherlands (available for download at <http://www.ecn.nl/docs/library/report/2005/rx05080.pdf>).



As a result, the baseline alternative chosen for the Project is the continuation of the current practice.

**Sub-step 4c:** Option II: Apply investment comparison.

Not applicable since a simple cost analysis has been carried out for the Project.

**Sub-step 4d:** Sensitivity analysis (only applicable when Option II is chosen).

Not applicable since option II is not chosen.

**Step 5: Re-assessment of Baseline Scenario in course of proposed project activity's lifetime:**

At the end of each crediting period, a re-assessment of the baseline scenario should be conducted, using the following steps:

**Sub-step 5a:** New or modified NO<sub>x</sub>-emission regulations

If new or modified NO<sub>x</sub>-emission regulations are introduced in the Host Country after the project starts, the determination of the baseline scenario will be re-assessed at the start of a crediting period. Baseline scenario alternatives to be analysed should include, inter alia:

- Selective Catalytic Reduction (SCR);
- Non-Selective Catalytic Reduction (NSCR);
- Tertiary measures incorporation like a selective catalyst for destroying N<sub>2</sub>O and NO<sub>x</sub> emissions;
- Continuation of the current practice.

Each time the baseline scenario needs to be re-assessed using the process described above (Step1-5). The methodology adjusts the baseline scenario are shown in Table 3.

Table 3. Re-assessment of the baseline scenario

| Potential outcomes of the re-assessment of the Baseline Scenario  | Adjusted baseline scenario  |
|---|---|
| installed SCR de-NO <sub>x</sub> unit   | Continuation of original (N <sub>2</sub> O) baseline scenario.  |
| installed NSCR de-NO <sub>x</sub> unit  | The outlet of N <sub>2</sub> O emissions of the NSCR de-NO <sub>x</sub> unit becomes the adjusted baseline scenario, as NSCR de-NO <sub>x</sub> units may reduce N <sub>2</sub> O as well as NO <sub>x</sub> emissions. |
| Tertiary measures that combine NO <sub>x</sub> and N <sub>2</sub> O emission reductions have been applied | Adjusted baseline scenario results in N <sub>2</sub> O emission reduction.  |
| Continuation of original baseline scenario  | Continuation of original baseline scenario.   |

**Sub-step 5b:** New or modified N<sub>2</sub>O-emission regulation

If legal regulation on N<sub>2</sub>O emissions are introduced or changed in the Host Country during the crediting period, the baseline emissions shall be adjusted at the time the legislation has to be legally implemented.



The key parameters which are needed to determine the baseline scenario for both sub-step 5a and 5b are shown in Table 4.

Table 4. Key parameters used for determination of the baseline scenario

| Key Parameters  | Detail                          | Data source    |
|---|---------------------------------|----------------|
| Current legal regulation pertaining to NO <sub>x</sub> emissions      | 700 ppm                         | GB16297-1996   |
| Current legal regulation pertaining to N <sub>2</sub> O emissions     | No regulation                   | Not applicable |
| Investment & operation cost for N <sub>2</sub> O destruction facility | No financial incentive exists   | N/A            |
| Income to finance the project activity                                | No other than CDM income exists | N/A            |

**B.5. Description of how the anthropogenic emissions of GHG by sources are reduced below those that would have occurred in the absence of the registered CDM project activity (assessment and demonstration of additionality): >>**

The following steps are used to demonstrate the additionality of the project according to the “*Tool for the demonstration and assessment of additionality*” (Version 03, EB29) agreed by the Executive Board.

**Step 1. Identification of alternatives to the project activity consistent with current laws and regulations**

Does not need to be reconceived since the identification of alternatives was already covered in the analysis carried out in section B.4. above.

**Step 2. Investment Analysis**

***Sub-step 2a: Determine appropriate analysis method***

The project activity will reduce N<sub>2</sub>O emissions inside the ammonia burner by installing a secondary catalyst in the burner basket located beneath the ammonia oxidation gauzes. The project will not generate financial benefits other than CDM revenues. Therefore, option I) simple cost analysis is chosen for the investment analysis.

***Sub-step 2b: Option I – Apply simple cost analysis***

The purpose of the cost analysis is to determine whether the proposed project activity without carbon revenue is financially less attractive than any other alternatives, which in this case is the current situation as in the identified baseline scenario. The identified baseline scenario does not require any cost with regards to the N<sub>2</sub>O emission.



For the proposed project activity, the cost estimation (without carbon revenue) is based on a 2001 report published by the Dutch government<sup>7</sup>. The report states that if 80% reduction of an assumed N<sub>2</sub>O emission in a European nitric acid plant is to be reached, then the average cost for five cost-competitive, high-temperature N<sub>2</sub>O abatement catalyst technologies is approximately €0.76/ tonnes of CO<sub>2</sub>e emission reduction. By applying these costs in the case of the proposed project, the cost of the proposed project is estimated as shown in Table 5.

Table 5. The cost of the proposed project

| Year  | Unit Cost of N <sub>2</sub> O abatement catalyst technology (€tonnes of CO <sub>2</sub> e) | Annual emission reductions (tonnes of CO <sub>2</sub> e) | Total annual cost of N <sub>2</sub> O abatement catalyst technology for the proposed project (€) |
|-------|--|--|--|
| 2008  | 0.76   | 108996   | 82837  |
| 2009  | 0.76   | 108996   | 82837  |
| 2010  | 0.76   | 108996   | 82837  |
| 2011  | 0.76   | 108996   | 82837  |
| 2012  | 0.76   | 108996   | 82837  |
| 2013  | 0.76   | 108996   | 82837  |
| 2014  | 0.76   | 108996   | 82837  |
| Total |  |  | 579859   |

Additionally, several other costs, though less than the costs shown in Table 5, may also be incurred: 1) the cost of purchasing and maintaining N<sub>2</sub>O abatement monitoring equipments; 2) the cost of burner modification (alloy materials for catalyst beds, etc.); 3) equipments import duties and transportation-related costs. Although these additional costs have not yet been taken into account in Table 5, the cost estimated in Table 5 is sufficient to demonstrate that the project scenario requires a rather significant amount of cost in N<sub>2</sub>O abatement catalyst technologies, none of which is required for the continuation of the current situation, as in the identified baseline scenario.

In conclusion, without the carbon revenue, the proposed project activity will only lead to significant costs, but no income at all. Therefore, the proposed project activity is not financially attractive when compared with the baseline scenario. Consequently, according to the “*Tool for the demonstration and assessment of additionality*” (Version 03 EB29), there is no need to proceed to Step 3.

### Step 3. Barrier Analysis

Barrier analysis is not used for demonstrating additionality in the proposed project, see the above step.

### Step 4. Common Practice Analysis

---

<sup>7</sup> Novem (2001). J. Kuiper. High temperature catalytic reduction of nitrous oxide emission from nitric acid production plants: ranking of catalytic methods that convert nitrous oxide partially into nitric oxide. Novem Project number 375001/0080. Dutch Ministry of Housing, Spatial Planning and Environment (VROM), The Hague, The Netherlands (available for download at <http://www.robklimaat.nl/docs/3750010080.pdf>).





The common practice analysis is a credibility check to complement the investment analysis (Step 2) or barrier analysis (Step 3) with an analysis of the extent to which the proposed project type (e.g. technology or practice) has already diffused in the relevant sector and region. The common practice in the Host Country will be identified and discussed through the following sub-steps:

***Sub-step 4a. Analyse other activities similar to the proposed activity***

N<sub>2</sub>O generated at current emission levels in nitric acid plants does not have any economic value, nor is it a toxic or damaging substance to human beings. Therefore, most countries do not have regulations or incentives to eliminate N<sub>2</sub>O emissions for nitric acid plants. Some studies, conducted by EFMA<sup>8,9</sup>, EU IPCC<sup>10</sup>, US EPA<sup>11</sup> and IPCC<sup>12</sup>, have already shown that N<sub>2</sub>O abatement technologies have not yet spread out into the nitric acid industry, not even in Annex I countries, except for initial industrial trials. The driving force to develop the technology and to conduct trials for secondary N<sub>2</sub>O abatement catalysts is actually based on the general expectation that some industrialised country governments, e.g. EU, USA, Canada and Japan, may eventually introduce caps on N<sub>2</sub>O emissions from large point sources such as nitric acid plants.

As for the Host Country, like most other countries, there is no regulation or incentive to eliminate N<sub>2</sub>O emissions for nitric acid plants. Consequently, the current situation for the nitric acid industry in the Host Country is that N<sub>2</sub>O gases generated from these sources are directly released to the atmosphere as a by-product without any further treatment. No similar activities to the proposed project activity have been observed to be implemented in the Host Country so far. In fact, many other companies in the Host Country are currently planning or developing similar CDM project activities.

***Sub-step 4b Discuss any similar options that are occurring***

No similar activities have been carried out in the Host Country without the consideration of the CDM. All plants with similar processes in the Host Country are considering or already preparing to implement CDM projects.

In conclusion, the continuation of the current situation is considered as the baseline scenario and therefore the proposed CDM project activity is additional.

---

<sup>8</sup> European Fertilizers Manufacturers Association (EFMA): Best Available Techniques for Pollution Prevention and Control in the European Fertilizer Industry (Booklet No. 2 of 8) "PRODUCTION OF NITRIC ACID", 2000.

<sup>9</sup> European Fertilizer Manufacturers (EFMA): "The European Fertilizer Manufacturers' Position on the European Commission's Proposal for a Directive on EU Emissions Trading", March 2005.

<sup>10</sup> Integrated Pollution Prevention and Control (IPPC): "Good Practice Guidance and Uncertainty Management in National Greenhouse Gas Inventories – N<sub>2</sub>O Emissions from Adipic Acid and Nitric Acid Production". Author Heike Mainhardt, ICF Inc, 2000.

<sup>11</sup> U.S. Adipic Acid and Nitric Acid N<sub>2</sub>O Emissions 1990-2020: Inventories, Projections and Opportunities for Reductions, US EPA November 2001

<sup>12</sup> Intergovernmental Panel on Climate Change (IPCC): "Default Factors for N<sub>2</sub>O from Nitric Acid Production", 2002.

**B.6. Emission reductions:****B.6.1. Explanation of methodological choices:**

&gt;&gt;

The Methodology version 2 is applicable to the proposed project activity as the project will install a secondary N<sub>2</sub>O abatement catalyst inside the ammonia burner of a nitric acid plant which catalytically reduces N<sub>2</sub>O once it has been formed in the Ammonia Oxidation Reactor.

The proposed project meets the following conditions required by the methodology:

- The proposed existing nitric acid production facility was erected and began operations in 1999 and has been operating steadily since then;
- No N<sub>2</sub>O abatement technology is currently installed in the proposed nitric acid plant;
- The project activity will not affect the level of nitric acid production at the proposed facility;
- There are currently no regulatory requirements or incentives to reduce levels of N<sub>2</sub>O emissions from nitric acid plants in the Host Country;
- At the proposed facility, there is no non-Selective Catalytic Reduction (NSCR) DeNO<sub>x</sub> unit;
- The project activity will not cause any increase of NO<sub>x</sub> emissions;
- There is no additional energy consumption, raw material consumption (ammonia, air, water) caused by the project activity. In addition, there is no leakage generated by the Project. Thus, the Project will not lead to any process emissions of greenhouse gases, neither directly nor indirectly;
- The monitoring system will be installed prior to the installation of the secondary catalyst and monitoring well be carried out for one complete campaign in accordance with EN 14181. The monitoring will continue after the installation of the secondary catalyst throughout the chosen crediting period of the project activity.

**Baseline emissions**

Baseline emissions are determined by measuring the N<sub>2</sub>O concentration and the total flow rate in the tail gas of the nitric acid plant. These measurements are made for the duration of one entire campaign, and will be used to determine a plant-specific baseline emission factor (tN<sub>2</sub>O / tHNO<sub>3</sub>). A permitted range for parameters that influence the level of N<sub>2</sub>O formation (e.g., ammonia, ammonia-air input, temperature and pressure) will be established during the baseline campaign to define the permitted range for which emission reduction credits can be claimed during the crediting period. These permitted ranges must also be demonstrated to be within the specifications of the plant.

The methodology requires the installation of a N<sub>2</sub>O monitoring system that includes both a gas volume flow meter and an infrared gas analyser to determine the concentration of N<sub>2</sub>O. The monitoring system will be installed in accordance with the European Norm 14181 (2004). The total mass of N<sub>2</sub>O emissions will be determined by multiplying the total volume flow by the concentration of N<sub>2</sub>O.

**Project emissions**

During the project activity, the measurement of N<sub>2</sub>O and other parameters will be carried out on a continuous basis and new emission factors will be established for each project campaign.

The project emission factor is calculated as the 'moving average' of the project emission factor of all the campaigns completed at that point in time. To determine the total emission reductions for a particular project campaign the project emission factor is determined as the higher of the two values: (i) the moving



average project emission factor; and (ii) the project emission factor for that particular campaign. Also, to account for any N<sub>2</sub>O emission reductions that may occur as a consequence of potential platinum deposit build up inside the plant, the moving average factor is capped at the level of the lowest campaign specific emission factor observed during the first 10 campaigns.

### Leakage emissions

No leakage effects need to be accounted under this methodology.

### Emission reductions

The total emission reductions for the project for a specific campaign are calculated by subtracting the project emissions factor from the baseline emissions factor and multiplying the result by the number of tonnes of nitric acid produced in the particular campaign.

Statistical analysis is applied to both the baseline emissions factor and each campaign-specific project emission factor. Only those N<sub>2</sub>O measurements from the operation within the permitted range in the plant have been taken and will be considered in the calculation of baseline emissions.

All equations used for calculating emission reductions, project emissions and baseline emissions are illustrated in section B 6.3.

#### B.6.2. Data and parameters that are available at validation:

|  |   |
|--|---|
| <b>Data / Parameter:</b>   | B.1 NCSG <sub>BC</sub>  |
| Data unit:   | mgN <sub>2</sub> O / m <sup>3</sup>   |
| Description:   | N <sub>2</sub> O concentration in the stack gas   |
| Source of data used:   | ADC MGA 3000 gas analyser <sup>13</sup>   |
| Value applied:   | 2940  |
| Justification of the choice of data or description of measurement methods and procedures actually applied: | <p>The parameter is continuously monitored in ppmv (every 2 seconds) according to AM0034 VERSION 02 requirements. Data taken during times when the plant is operating outside the permitted operating range are eliminated. The remaining data is converted from ppmv to mgN<sub>2</sub>O / m<sup>3</sup> with the following formula:<br/> <math display="block">NCSG = ppmv * RMM / v</math>           Where:<br/> <i>ppmv</i> means parts per million of volume<br/> <i>RMM</i> means relative molecular mass of N<sub>2</sub>O (44.013 g)<br/> <i>v</i> means volume of an ideal gas at standard temperature and pressure (22.4 Nm<sup>3</sup>)</p> <p>Once converted into mgN<sub>2</sub>O / m<sup>3</sup> the data is subjected to a statistical analysis according to the AM0034 VERSION 02 requirements.</p> |
| Any comment:   | The data output from the analyser is logged in a Data Storage Unit (DSU). A PC is used to extract the raw data files. The algorithms used on the software will be available to the DOE.   |

<sup>13</sup> Detailed information on the operation parameters and certificates of MGA3000 analyser are available for the DOE.



|   |   |
|---|---|
| <b>Data / Parameter:</b>  | B.2 VSG <sub>BC</sub>   |
| Data unit:  | Nm <sup>3</sup> / h   |
| Description:  | Normal gas volume flow rate of the stack gas during the baseline campaign   |
| Source of data used:  | Averaging pitot tube differential pressure flow meter for corrosive applications (Systec DF25)  |
| Value applied:  | 20000   |
| Justification of the choice of data or description of measurement methods and procedures actually applied : | The parameter is logged continuously in the DSU (every 2 seconds). Data taken during times when the plant is operating outside the permitted operating range are eliminated.<br><br>Temperature and pressure are also measured at the same location as the flow meter to allow the normalisation of the flow automatically. |
| Any comment:  | None  |

|   |   |
|---|---|
| <b>Data / Parameter:</b>  | B.3 BE <sub>BC</sub>  |
| Data unit:  | tN <sub>2</sub> O   |
| Description:  | Total N <sub>2</sub> O for baseline campaign  |
| Source of data used:  | Calculation from measured data  |
| Value applied:  | 106   |
| Justification of the choice of data or description of measurement methods and procedures actually applied : | The total mass N <sub>2</sub> O emission during the baseline campaign are determined as a product of NCSG <sub>BC</sub> , VSG <sub>BC</sub> and OH <sub>BC</sub> using Equation (1) according to AM0034 VERSION 02.<br><br>$BE_{BC} = NCSG_{BC} * VSG_{BC} * 10^{-9} * OH_{BC}$ |
| Any comment:  |   |

|   |  |
|---|--|
| <b>Data / Parameter:</b>  | B.4 OH <sub>BC</sub>   |
| Data unit:  | hours  |
| Description:  | Operating hours of the plant   |
| Source of data used:  | Production log   |
| Value applied:  | 1800   |
| Justification of the choice of data or description of measurement methods and procedures actually applied : | During the baseline campaign, all data values outside the CL <sub>normal</sub> are excluded. |
| Any comment:  | None   |

|                          |   |
|--------------------------|---|
| <b>Data / Parameter:</b> | B.5 NAP <sub>BC</sub>   |
| Data unit:               | tHNO <sub>3</sub>   |
| Description:             | Nitric acid (100% concentrated) production over baseline campaign |
| Source of data used:     | Production log  |
| Value applied:           | 14400   |



## CDM – Executive Board

page 21

|   |   |
|---|---|
| Justification of the choice of data or description of measurement methods and procedures actually applied : | This parameter will be monitored by the project operator using a flow meter. Description of sampling method to calculate the product's density – this is site specific. During the baseline campaign, all data values outside the $CL_{normal}$ are excluded. |
| Any comment:  | None  |

|   |  |
|---|--|
| <b>Data / Parameter:</b>  | B.6 TSG  |
| Data unit:  | Degrees Centigrade (°C)  |
| Description:  | Temperature of stack gas   |
| Source of data used:  | Probe (integrated in volume flow meter or a separate probe inserted adjacent to flow meter)  |
| Value applied:  | N/A  |
| Justification of the choice of data or description of measurement methods and procedures actually applied : | The data is recorded continuously (every 2 seconds) but is not reported.   |
| Any comment:  | The temperature measurement on the stack-is required to obtain the volume flow at normal conditions ( $Nm^3/h$ ) in the stack, but is not required to be reported as a separated parameter according to AM0034 VERSION 02. |

|   |  |
|---|--|
| <b>Data / Parameter:</b>  | B.7 PSG  |
| Data unit:  | Bar  |
| Description:  | Pressure of stack gas  |
| Source of data used:  | Probe (part of gas volume flow meter)  |
| Value applied:  |  |
| Justification of the choice of data or description of measurement methods and procedures actually applied : | The data is recorded continuously (every 2 seconds) and reported according to AM0034 VERSION 02.   |
| Any comment:  | The temperature measurement on the stack-is required to obtain the volume flow at normal conditions ( $Nm^3/h$ ) in the stack, but is not required to be reported as a separated parameter according to AM0034 VERSION 02. |

|                          |   |
|--------------------------|---|
| <b>Data / Parameter:</b> | B.8 $EF_{BL}$   |
| Data unit:               | $tN_2O / tHNO_3$  |
| Description:             | Emissions factor for baseline period  |
| Source of data used:     | Calculated from measured data ( tons of $N_2O$ emitted/ tons of nitric acid produced) |
| Value applied:           | $7.0 \cdot 10^{-3}$   |
| Justification of the     | The Emissions factor for the baseline campaign are determined using equation          |



## CDM – Executive Board

page 22

|  |   |
|--|---|
| choice of data or description of measurement methods and procedures actually applied : | (2) according to AM0034 VERSION 02:<br>$EF_{BL} = (BE_{BC} / NAP_{BC})(1 - UNC / 100) \text{ (tN}_2\text{O/tHNO}_3\text{)}$ |
| Any comment:   | None  |

|   |   |
|---|---|
| <b>Data / Parameter:</b>  | B.9 UNC   |
| Data unit:  | %   |
| Description:  | Overall measurement uncertainty of the monitoring system  |
| Source of data used:  | Calculation of the combined uncertainty of the applied monitoring equipment   |
| Value applied:  | 4.5   |
| Justification of the choice of data or description of measurement methods and procedures actually applied : | Once the monitoring system is commissioned the overall uncertainty will be determined with several reference measurements in compliance with EN14181 standards; to be carried out by an accredited third party. |
| Any comment:  |   |

|   |  |
|---|--|
| <b>Data / Parameter:</b>  | B.10 AFR   |
| Data unit:  | kgNH <sub>3</sub> /h   |
| Description:  | Ammonia gas flow rate to the Ammonia Oxidation Reactor (AOR)   |
| Source of data used:  | Monitored  |
| Value applied:  | Not applicable, monitoring data of AFR will be used to determine if the plant is exceeding the AFR <sub>max</sub> .  |
| Justification of the choice of data or description of measurement methods and procedures actually applied : | According to AM0034 VERSION 02 the AFR has to be monitored during the baseline campaign in order to eliminate the NCSG and VSG from those when the plant is exceeding the AFR <sub>max</sub> . |
| Any comment:  |  |

|   |   |
|---|---|
| <b>Data / Parameter:</b>  | B.11 AFR <sub>max</sub>   |
| Data unit:  | Nm <sup>3</sup> NH <sub>3</sub> /h  |
| Description:  | Maximum ammonia flow rate   |
| Source of data used:  | Plant records   |
| Value applied:  | 4100  |
| Justification of the choice of data or description of measurement methods and procedures actually applied : | AFR <sub>max</sub> is used to determine those periods when the plant is operating outside the permitted conditions. The AFR data from last 5 campaigns was used to determine AFR <sub>max</sub> . During these campaigns after the exclusion of all data outside a 95% confidence interval. |



|              |      |
|--------------|------|
| Any comment: | None |
|--------------|------|

|   |  |
|---|--|
| <b>Data / Parameter:</b>  | B.12 AIFR  |
| Data unit:  | % v/v of NH <sub>3</sub> in air  |
| Description:  | Ammonia to Air ratio into the AOR  |
| Source of data used:  | Monitored & calculated   |
| Value applied:  | Not applicable, monitored data of AIFR will only be used to determine periods when the plant is operating outside of AIFR <sub>max</sub> .   |
| Justification of the choice of data or description of measurement methods and procedures actually applied : | According to AM0034 VERSION 02, the AIFR is obtained from the operating condition campaign in order to determine the AIFR <sub>max</sub> . The permitted range of NH <sub>3</sub> to Air ratio is taken from the data of the historic campaigns. The primary air flow is measured with a flow meter. |
| Any comment:  | AM0034 VERSION 02 states the AIFR should be measured in m <sup>3</sup> /h, this is a mistake and such parameter should be expressed as a ratio or percentage volume by volume of Ammonia in Air.   |

|   |  |
|---|--|
| <b>Data / Parameter:</b>  | B.13 CL <sub>BL</sub>  |
| Data unit:  | tHNO <sub>3</sub>  |
| Description:  | Campaign length of baseline campaign measured in metric tonnes of 100% concentrated nitric acid produced.  |
| Source of data used:  | Calculated from NAP <sub>BC</sub>  |
| Value applied:  | 14400  |
| Justification of the choice of data or description of measurement methods and procedures actually applied : | Calculated according to AM0034 VERSION 02 after the end of each campaign. Based on every tonne of nitric acid produced during the baseline campaign, regardless of whether the measured NCSG and VSG data were excluded or not from the relevant period. |
| Any comment:  | None   |

|   |   |
|---|---|
| <b>Data / Parameter:</b>  | B.14 CL <sub>normal</sub>   |
| Data unit:  | tHNO <sub>3</sub>   |
| Description:  | Normal campaign length  |
| Source of data used:  | Production log from five historic campaigns   |
| Value applied:  | hand-written logs being converted into electronic version   |
| Justification of the choice of data or description of measurement methods and procedures actually applied : | CL <sub>normal</sub> is used to adjust CL <sub>BL</sub> and NAP <sub>BC</sub> in accordance with AM0034 VERSION 02. |
| Any comment:  | Average historical campaign length during the operation condition campaign.   |

|                          |                          |
|--------------------------|--------------------------|
| <b>Data / Parameter:</b> | B.15 AIFR <sub>max</sub> |
|--------------------------|--------------------------|



|   |  |
|---|--|
| Data unit:  | % v/v of NH <sub>3</sub> in air  |
| Description:  | Maximum ammonia to air ratio   |
| Source of data used:  | Calculated from measured data of AFR and primary air flow rate.  |
| Value applied:  | 10   |
| Justification of the choice of data or description of measurement methods and procedures actually applied : | In practice, AIFR is a critical parameter for controlling the plant's operation. The critical limit for the plant is an AIFR of 13%; if the ammonia ratio is higher the plant will “trip” or shut down automatically.<br>As the measurement of AIFR continues during shutdown periods, some extreme vales are recorded. Even after the 95% confidence interval statistical analysis of AIFR data, fairly high values remains valid in accordance with the methodology. However, when O <sub>th</sub> , O <sub>ph</sub> , AFR <sub>max</sub> , AIFR <sub>max</sub> limits are applied to the baseline campaign, the remaining values are below the “trip” threshold, therefore is unnecessary to us the critical AIFR as AIFR <sub>max</sub> value. |
| Any comment:  | AM0034 VERSION 02 states the AIFR <sub>max</sub> should be measured in m <sup>3</sup> /h, this is a mistake and such parameter should be expressed as a ratio or percentage volume by volume of Ammonia in Air.  |

|   |   |
|---|---|
| <b>Data / Parameter:</b>  | B.16 OT <sub>h</sub>  |
| Data unit:  | Degrees Centigrade (°C) (min and max)   |
| Description:  | Oxidation temperature for each hour during baseline campaign  |
| Source of data used:  | Monitored with thermocouples inside the AOR   |
| Value applied:  | Not applicable, used to determine if OT <sub>h</sub> during baseline campaign exceeds the OT <sub>normal</sub> .  |
| Justification of the choice of data or description of measurement methods and procedures actually applied : | The parameter is monitored and compared with the normal range for oxidation temperature (OT <sub>normal</sub> ) according to AM0034 VERSION 02. VSG and NCSG data obtained during periods where OT <sub>h</sub> is above or below the OT <sub>normal</sub> range are eliminated from the EF <sub>BL</sub> calculations. |
| Any comment:  | None  |

|   |   |
|---|---|
| <b>Data / Parameter:</b>  | B.17 OT <sub>normal</sub>   |
| Data unit:  | Degrees Centigrade (°C)   |
| Description:  | Normal operating temperature  |
| Source of data used:  | Monitored by thermocouples inside the AOR during historical campaigns.  |
| Value applied:  | 860°C and 880°C   |
| Justification of the choice of data or description of measurement methods and procedures actually applied : | Measurements are taken by a thermocouple inside the AOR. and then a 95% confidence interval statistical analysis has been applied, eliminating all values out of the range. The remaining range of values represent the maximum and minimum normal operating temperatures in the AOR. |
| Any comment:  | None  |

|                          |                                  |
|--------------------------|----------------------------------|
| <b>Data / Parameter:</b> | B.18 OP <sub>h</sub>             |
| Data unit:               | Bar                              |
| Description:             | Oxidation Pressure for each hour |





## CDM – Executive Board

page 25

|   |  |
|---|--|
| Source of data used:  | Monitored by pressure transmitter  |
| Value applied:  | Not applicable, used to determine if $OP_h$ during baseline campaign exceeds the $OP_{normal}$ .   |
| Justification of the choice of data or description of measurement methods and procedures actually applied : | The parameter is monitored and compared with the normal range of oxidation pressure ( $OP_{normal}$ ) according to AM0034 VERSION 02. The location of the pressure transmitter remains the same before and after the baseline monitoring. VSG and NCSG data obtained from periods where $OP_h$ lies outside the ranges for $OP_{normal}$ are eliminated from the $EF_{BL}$ calculations. |
| Any comment:  | None   |

|   |  |
|---|--|
| <b>Data / Parameter:</b>  | B.19 $OP_{normal}$   |
| Data unit:  | bar (gauge)  |
| Description:  | Normal operating pressure  |
| Source of data used:  | Monitored by pressure transmitter  |
| Value applied:  | 6.6 bar  |
| Justification of the choice of data or description of measurement methods and procedures actually applied : | Measurements are taken by a pressure transmitter. and then a 95% confidence interval statistical analysis has been applied, eliminating all values out of the range. The remaining range of values represent the maximum and minimum normal operating pressures in the AOR. The location of the pressure transmitter remains the same before and after the baseline monitoring |
| Any comment:  | None   |

|   |   |
|---|---|
| <b>Data / Parameter:</b>  | B.20 $GS_{normal}$  |
| Data unit:  | Name of supplier  |
| Description:  | Normal gauze supplier for the operation condition campaigns   |
| Source of data used:  | Monitored   |
| Value applied:  | Guiyuan Platium   |
| Justification of the choice of data or description of measurement methods and procedures actually applied : | The value for $GS_{normal}$ is only a plausibility check,, it can be used for the comparison of $GC_{normal}$ and $GC_{BL}$ . |
| Any comment:  | None  |

|   |                                      |
|---|--------------------------------------|
| <b>Data / Parameter:</b>  | B.21 $GS_{BL}$                       |
| Data unit:  | Name of supplier                     |
| Description:  | Gauze supplier for baseline campaign |
| Source of data used:  | Monitored                            |
| Value applied:  | Guiyuan Platium                      |
| Justification of the choice of data or description of measurement methods | See B.20 above.                      |



## CDM – Executive Board

page 26

|                                   |      |
|-----------------------------------|------|
| and procedures actually applied : |      |
| Any comment:                      | None |

|   |  |
|---|--|
| <b>Data / Parameter:</b>  | B.22 GS <sub>project</sub>   |
| Data unit:  | Name of supplier   |
| Description:  | Gauze supplier for the project campaigns   |
| Source of data used:  | Monitored  |
| Value applied:  | Guiyuan Platium  |
| Justification of the choice of data or description of measurement methods and procedures actually applied : | The parameter is monitored according to AM0034 VERSION 02 during the project campaign. |
| Any comment:  | None   |

|   |   |
|---|---|
| <b>Data / Parameter:</b>  | B.23 GC <sub>normal</sub>   |
| Data unit:  | %   |
| Description:  | Gauze composition during the five historic campaigns expressed as percentage by weight of precious metals (Platinum, Rhodium and Palladium) of the AOR gauzes.  |
| Source of data used:  | Monitored   |
| Value applied:  | Platium: 90; Rhodium: 10  |
| Justification of the choice of data or description of measurement methods and procedures actually applied : | According to AM0034 VERSION 02, if the composition of the ammonia oxidation catalyst used for the baseline campaign and after the implementation of the project are identical to that used in the previous five campaigns, then there shall be no limitations on the N <sub>2</sub> O baseline emissions. |
| Any comment:  | None  |

|   |  |
|---|--|
| <b>Data / Parameter:</b>  | B.24 GC <sub>BL</sub>  |
| Data unit:  | %  |
| Description:  | Gauze composition during the baseline campaign expressed as percentage by weight of precious metals (Platinum, Rhodium and Palladium) of the AOR gauzes.   |
| Source of data used:  | Monitored  |
| Value applied:  | Platium: 90; Rhodium: 10   |
| Justification of the choice of data or description of measurement methods and procedures actually applied : | According to AM0034 VERSION 02, if the composition of the ammonia oxidation catalyst used for the baseline campaign and after the implementation of the project are identical to that used in the previous five campaigns, then there shall be no limitations on the N <sub>2</sub> O baseline emissions. Since the gauze composition has been the same during the baseline and the five previous campaigns, there are no limitations on the N <sub>2</sub> O emissions. |
| Any comment:  | None   |



|   |  |
|---|--|
| <b>Data / Parameter:</b>  | B.25 GC <sub>project</sub>   |
| Data unit:  | %  |
| Description:  | Gauze composition during the project campaign expressed as percentage by weight of precious metals (Platinum, Rhodium and Palladium) of the AOR gauzes.  |
| Source of data used:  | Monitored  |
| Value applied:  | To be determined during the project campaigns  |
| Justification of the choice of data or description of measurement methods and procedures actually applied : | The parameter is monitored and recorded according to AM0034 VERSION 02. If the GC <sub>project</sub> is different from GC <sub>BL</sub> , the baseline campaign must be repeated or a conservative IPCC default emission factor applied. |
| Any comment:  | None   |

|   |   |
|---|---|
| <b>Data / Parameter:</b>  | B.26 EF <sub>reg</sub>  |
| Data unit:  | tN <sub>2</sub> O / tHNO <sub>3</sub>   |
| Description:  | Emissions cap for N <sub>2</sub> O from nitric acid (HNO <sub>3</sub> ) set by government of Host Country.      |
| Source of data used:  | Chinese Environmental Law   |
| Value applied:  | None  |
| Justification of the choice of data or description of measurement methods and procedures actually applied : | Currently there is no N <sub>2</sub> O-emission regulation in place for nitric acid plants in the Host Country. |
| Any comment:  | None  |

### B.6.3 Ex-ante calculation of emission reductions:

>>

In compliance with the approved baseline methodology AM0034 VERSION 02, the procedures on how to calculate project emissions, baseline emissions, leakage emission and emission reductions for the proposed CDM project are shown in this section.

#### Project emissions

Over the duration of the project activity the N<sub>2</sub>O concentration and gas volume flow in the stack of the nitric acid plant as well as the temperature and pressure of the ammonia gas flow and the ammonia-to-air ratio will be measured continuously. The following steps are required to calculate the campaign-specific emission factor:

#### Estimation of campaign-specific project emissions

Equation 7 shows how to calculate total N<sub>2</sub>O emissions of the *n*th project campaign:



$$PE_n = VSG * NCSG * 10^{-9} * OH \quad (\text{tN}_2\text{O}) \quad (7)$$

where,

|                 |   |
|-----------------|---|
| VSG             | Mean stack gas volume flow rate for the project campaign (m <sup>3</sup> /h)  |
| NCSG            | Mean concentration of N <sub>2</sub> O in the stack gas for the project campaign (mgN <sub>2</sub> O / m <sup>3</sup> ) |
| OH              | Is the number of hours of operation in the specific monitoring period (h)   |
| PE <sub>n</sub> | Calculated total N <sub>2</sub> O emissions of the <i>n</i> th project campaign (tN <sub>2</sub> O) using equation (7)  |

For this project the following values are applied:

$$PE_n = 20000 * 588 * 10^{-9} * 1800 = 21 \text{ (tN}_2\text{O)}$$

#### Calculation of campaign-specific emission factor

As shown in Equation 8 below, a campaign-specific emission factor during the project's crediting period will be calculated by dividing the total mass of N<sub>2</sub>O emissions during that campaign by the total production of nitric acid (100%) during that same campaign.

$$EF_n = PE_n / NAP_n \quad (\text{tN}_2\text{O} / \text{tHNO}_3) \quad (8)$$

Where:

|                  |   |
|------------------|---|
| NAP <sub>n</sub> | Nitric acid production (tHNO <sub>3</sub> , 100% concentration) during the project campaign <i>n</i> with <i>n</i> = 1 to 5     |
| PE <sub>n</sub>  | Total N <sub>2</sub> O emissions (tN <sub>2</sub> O) of the project campaign <i>n</i> with <i>n</i> = 1 to 5                    |
| EF <sub>n</sub>  | Calculated emission factor calculated for a specific project campaign (tN <sub>2</sub> O/tHNO <sub>3</sub> ) using equation (8) |

For this project the following values are applied:

$$EF_n = 21/14400 = 1.5 * 10^{-3} \quad (\text{tN}_2\text{O} / \text{tHNO}_3)$$

#### Derivation of a moving average emission factor

A conservative approach of applying a moving average emission factor is estimated as shown in Equation 9 in order to take into account possible long-term emissions trends over the duration of the project activity.

$$EF_{ma,n} = (EF_1 + EF_2 + \dots + EF_n) / n \quad (\text{tN}_2\text{O} / \text{tHNO}_3) \quad (9)$$

|                    |   |
|--------------------|---|
| EF <sub>ma,n</sub> | Moving average (ma) emission factor of after campaigns <i>n</i> including the current campaign (tN <sub>2</sub> O / tHNO <sub>3</sub> ) |
| <i>n</i>           | Number of campaigns to date   |

At this stage *n* = 1, so EF<sub>ma,n</sub> = EF<sub>n</sub>

#### Minimum project emission factor



A minimum project emission factor,  $EF_{min}$  is defined as the lowest  $EF_n$  observed during the first 10 campaigns of the project crediting period ( $N_2O / tHNO_3$ ). If any of the later project campaign results in an  $EF_n$  which is lower than  $EF_{min}$ , the calculation of the emission reductions for that particular campaign shall use  $EF_{min}$  not  $EF_n$ .

#### Determination of campaign-specific emission factor

The final determination of the campaign-specific emission factor,  $EF_p$ , which will be used to calculate the emission reduction during the specific campaign need to take into account the moving average emission factor ( $EF_{ma,n}$ ), minimum project emission factor ( $EF_{min}$ ). Table 6 shows different scenarios for choosing the emission factor ( $EF_p$ ) which shall be used to calculate the emission from a particular campaign

Table 6. Different scenarios for choosing campaign-specific emission factor

| Scenarios | During the first 10 campaigns |                    | After the first 10 campaigns |  |
|-----------|-------------------------------|--------------------|------------------------------|--|
|           | $EF_{ma,n} > EF_n$            | $EF_{ma,n} < EF_n$ | $EF_n < EF_{min}$            | $EF_n > EF_{min}$                        |
| $EF_p$    | $EF_{ma,n}$                   | $EF_n$             | $EF_{ma,n}$                  | the higher one of $EF_n$ and $EF_{ma,n}$ |

After 10 campaigns, if one  $EF_n$  is less than  $EF_{min}$ , then it is  $EF_{min}$  that should be used to calculate  $EF_{ma,n}$ , not  $EF_n$ .

#### **Baseline emissions**

The baseline shall be established through continuous monitoring of both  $N_2O$  concentration and gas flow volume in the stack of the nitric acid plant for one complete campaign prior to project implementation. The following steps are used to estimate the baseline  $N_2O$  emissions factor:

#### Estimation of the baseline $N_2O$ emissions

The total  $N_2O$  emissions during the baseline campaign will be obtained by applying Equation 10.

$$BE_n = VSG_{BC} * NCSG_{BC} * 10^{-9} * OH_{BC} \text{ (tN}_2\text{O)} \quad (10)$$

For this project the following values are applied:

$$BE_n = 20000 * 2940 * 10^{-9} * 1800 = 106 \text{ (tN}_2\text{O)}$$

The plant specific baseline emission factor representing the average  $N_2O$  emissions per tonne of nitric acid over one full campaign is derived by dividing the total mass of  $N_2O$  emissions by the total output of nitric acid (100%) for that period. However, the overall uncertainty of the monitoring system, expressed as a percentage ( $UNC$ ), shall be considered when calculating the baseline emission factor. Finally, the following Equation (11) is used to calculate the baseline emission factor:

$$EF_{BL} = (BE_{BC} / NAP_{BC})(1 - UNC / 100) \text{ (tN}_2\text{O/tHNO}_3\text{)} \quad (11)$$

For this project the following values are applied:



$$EF_{BL} = (106/14400) * (1 - 4.5/100) = 7.0 * 10^{-3} \quad (\text{tN}_2\text{O}/\text{tHNO}_3)$$

Where:

|             |  |
|-------------|--|
| $NCSG_{BC}$ | Mean concentration of $N_2O$ in the stack gas during the baseline campaign ( $\text{mgN}_2\text{O}/\text{m}^3$ )             |
| $OH_{BC}$   | Operating hours of the baseline campaign (h)   |
| $VSG_{BC}$  | Mean gas volume flow rate at the stack in the baseline measurement period ( $\text{m}^3/\text{h}$ )                          |
| $NAP_{BC}$  | Nitric acid production during the baseline campaign ( $\text{tHNO}_3$ )  |
| UNC         | Overall uncertainty of the monitoring system, calculated as the combined uncertainty of the applied monitoring equipment (%) |
| $BE_{BC}$   | Calculated total $N_2O$ emissions during the baseline campaign ( $\text{tN}_2\text{O}$ ) using Equation 10                   |
| $EF_{BL}$   | Calculated baseline $N_2O$ emissions factor ( $\text{tN}_2\text{O}/\text{tHNO}_3$ ) using Equation 11                        |

#### Determination of baseline $N_2O$ emission factor

In order to make the final determination of baseline  $N_2O$  emission factor, the factors need to be considered. These factors include impact of regulations, the ammonia oxidation catalyst composition change and baseline campaign length.

| Scenarios                | Normal case | Impact of regulations |                      | Ammonia catalyst<br>Permissible change | oxidation<br>Non-permissible change<br>IPCC default value or repeat the baseline campaign | Baseline campaign length |  |
|--------------------------|-------------|-----------------------|----------------------|--|---|--------------------------|--|
|                          |             | $EF_{BL} > EF_{reg}$  | $EF_{BL} < EF_{reg}$ |  |   | $CL_{BL} < CL_{normal}$  | $CL_{BL} > CL_{normal}$  |
| Baseline emission factor |             | $EF_{reg}$            | $EF_{BL}$            | $EF_{BL}$                              |   | $EF_{BL}$                | Adjusted $EF_{BL}$ by eliminating those $N_2O$ beyond the $CL_n$ |

#### **Leakage emissions**

No leakage effects need to be accounted under this methodology.

#### **Emission reductions**

The emission reductions for the project activity over a specific campaign are determined by deducting the campaign-specific emission factor from the baseline emission factor and multiplying the result by the production output of nitric acid (100%) over the campaign period and the GWP of  $N_2O$ . The calculation is shown in Equation (12).

$$ER = (EF_{BL} - EF_P) * NAP * GWP_{N_2O} \quad (\text{tCO}_2\text{e}) \quad (12)$$

For this project the following values are applied:

$$ER = (7.0 - 1.5) * 10^{-3} * 14,400 * 310 = 24,552 \quad (\text{tCO}_2\text{e})$$



Where:

- NAP Nitric acid production for the project campaign (tHNO<sub>3</sub>). The maximum value of NAP shall not exceed the design capacity.
- EF<sub>BL</sub> Baseline emissions factor (tN<sub>2</sub>O / tHNO<sub>3</sub>)
- EF<sub>P</sub> Emissions factor used to calculate the emissions from this particular campaign (i.e. the higher of EF<sub>ma,n</sub> and EF<sub>n</sub>)
- ER Calculated mission reductions of the project for the specific campaign (tCO<sub>2</sub>e) using Equation (12)
- GWP<sub>N<sub>2</sub>O</sub> Global warming potential of N<sub>2</sub>O is 310 times of CO<sub>2</sub>

It is assumed that the annual production days (330 days) and the campaign lengths (75 days) in the past years will remain the same in the next seven years. The annual production of nitric acid NHO3 in the next seven years is expected to be 63,360 tonnes per year. See details in Section B.6.2. and A.4.4. The ex-ante estimation of emission reductions for the next seven years is summarized in Section B.6.4.

#### **B.6.4 Summary of the ex-ante estimation of emission reductions:**

>>

| Year                                   | Estimation of project activity emissions (tonnes of CO <sub>2</sub> e) | Estimation of baseline emissions (tonnes of CO <sub>2</sub> e) | Estimation of leakage (tonnes of CO <sub>2</sub> e) | Estimation of overall emission reduction (tonnes of CO <sub>2</sub> e) |
|--|--|--|---|--|
| 2008                                   | 28873  | 137869   | 0   | 108996   |
| 2009                                   | 28873  | 137869   | 0   | 108996   |
| 2010                                   | 28873  | 137869   | 0   | 108996   |
| 2011                                   | 28873  | 137869   | 0   | 108996   |
| 2012                                   | 28873  | 137869   | 0   | 108996   |
| 2013                                   | 28873  | 137869   | 0   | 108996   |
| 2014                                   | 28873  | 137869   | 0   | 108996   |
| Total<br>(tonnes of CO <sub>2</sub> e) | 202112   | 965085   | 0   | 762973   |

#### **B.7 Application of the monitoring methodology and description of the monitoring plan:**

The monitoring methodology applied is the approved monitoring methodology AM0034 VERSION 02 “Catalytic reduction of N<sub>2</sub>O inside the ammonia burner of nitric acid plants”. The proposed project meets all the applicability requirements of this methodology.

This monitoring methodology requires the collection of historic N<sub>2</sub>O emissions baseline data, and the monitoring of ammonia and air input, as well as pressure and temperature inside the ammonia burner during one production campaign of the nitric acid plant, prior to the installation of the N<sub>2</sub>O abatement catalyst. Further is requires the continued monitoring of the N<sub>2</sub>O emissions after the installation of the N<sub>2</sub>O abatement catalyst.

The Automated Measuring System (AMS), covered by the EN14181:2004 ‘Stationary Source Emissions’ will be applied to the gas analyser and the volume flow meter as demonstrated below:



- An automated extractive gas analyzer system that uses Non Dispersive Infrared Absorption (NDIR) (including probes, pipes and sample conditioning system) that will continuously measure the concentration of N<sub>2</sub>O in the stack gas of the nitric acid plant will be installed. A probe extracts the homogeneously mixed gas directly from the stack from the point at which it is pumped through gas lines to the analyzer, and
- A gas volume flow meter that uses pressure-differential to continuously monitor the gas volume flow, temperature and pressure, will be installed in the stack of the nitric acid plant.

|   |
|---|
| <b>B.7.1 Data and parameters monitored:</b> |
|---|

|  |   |
|--|---|
| <b>Data / Parameter:</b>   | P.1 NCSG  |
| Data unit:   | mgN <sub>2</sub> O / m <sup>3</sup>   |
| Description:   | N <sub>2</sub> O concentration in the stack gas   |
| Source of data to be used:   | ADC MGA3000 gas analyser <sup>14</sup>  |
| Value of data applied for the purpose of calculating expected emission reductions in section B.5 | To be monitored during project campaigns  |
| Description of measurement methods and procedures to be applied:                                 | <p>The parameter is continuously monitored (every second) in ppmv according to AM0034 VERSION 02 requirements. Data taken during times when the plant is operating outside the permitted operating range will be eliminated. The remaining data will be converted from ppmv into mg N<sub>2</sub>O / m<sup>3</sup> with the following formula:</p> $\text{NCSG} = \text{ppmv} * \text{RMM} / v$ <p>Where:</p> <p><i>ppmv</i> means parts per million of volume<br/> <i>RMM</i> means relative molecular mass of N<sub>2</sub>O (44.013 mg)<br/> <i>v</i> means volume of an ideal gas (22.4 Nm<sup>2</sup>)</p>   |
| QA/QC procedures to be applied:  | <p>Staff will be trained for the installation, calibration, operation and regular maintenance of the AMS. Daily checks of the gas analysis system will be performed by trained staff. Zero and span calibrations will be conducted on a regular basis according to the manufacturer's recommendations. Procedures for conducting calibrations will be kept on site along with forms to record calibrations.</p> <p>Trained staff will follow procedures to report any abnormalities or equipment failure. A reliable technical support infrastructure will be established based locally in China as well as regular support from the manufacturer</p> <p>Essential spare parts will be kept on-site to guarantee optimum uptime</p> |

<sup>14</sup> Detailed information on the operation parameters and certificates of ADC MGA3000 gas analyser are available for the DOE.





|              |   |
|--------------|---|
|              | performance. Part of the staff training will be in the replacement of essential spare parts. Any maintenance requirements outside of the capabilities of site staff will be performed by maintenance engineers trained by the equipment manufacturer. |
| Any comment: | The data output from the analyser is stored in a DSU. A PC is used to extract the raw data files.   |

|  |   |
|--|---|
| <b>Data / Parameter:</b>   | P.2 VSG   |
| Data unit:   | Nm <sup>3</sup> /h  |
| Description:   | Normal gas volume flow rate of the stack gas during each project campaign   |
| Source of data to be used:   | Averaging pitot tube flow meter for corrosive applications (Systec model DF25)  |
| Value of data applied for the purpose of calculating expected emission reductions in section B.5 | To be calculated during project campaigns   |
| Description of measurement methods and procedures to be applied:                                 | <p>The parameter is continuously monitored in Nm<sup>3</sup>/h and stored in the DSU. Data taken during times when the plant is operating outside the permitted operating range will be eliminated.</p> <p>The flow meter measures differential pressure which is used to calculate the volumetric flow rate (normalised for temperature and pressure). The pressure and temperature of the stack gas are measured adjacent to the differential pressure.</p>   |
| QA/QC procedures to be applied:  | <p>The flow meter will be installed by the supplier of the stack monitoring system. Site staff will receive training on the maintenance checks of the flow meter to ensure that it remains fully operational. The flow meter is factory calibrated and will be subject to future local calibrations in accordance with the manufacturer's recommendations</p> <p>Uncertainties in the data measured by the flow meter will be checked by an accredited third party according to AM0034 VERSION 02. For downtime management and detailed QA/QC procedures see monitoring plan.</p> |
| Any comment:   |   |

|  |  |
|--|--|
| <b>Data / Parameter:</b>   | P.3 PE <sub>n</sub>  |
| Data unit:   | tN <sub>2</sub> O  |
| Description:   | N <sub>2</sub> O emissions of <i>n</i> th project campaign |
| Source of data to be used:   | Calculation from measured data                             |
| Value of data applied for the purpose of calculating expected emission reductions in | To be calculated during project campaigns                  |



## CDM – Executive Board

|  |  |
|--|--|
| section B.5  |  |
| Description of measurement methods and procedures to be applied: | The parameter will be calculated according to AM0034 VERSION 02. |
| QA/QC procedures to be applied:                                  | Not applicable. Calculated value.                                |
| Any comment:   | None   |

|  |   |
|--|---|
| <b>Data / Parameter:</b>   | P.4 OH  |
| Data unit:   | Hours   |
| Description:   | Operating hours during each project campaign  |
| Source of data to be used:   | Production log  |
| Value of data applied for the purpose of calculating expected emission reductions in section B.5 | To be determined during project campaigns   |
| Description of measurement methods and procedures to be applied:                                 | Plant operator will record the operation hours and production during each project campaign. |
| QA/QC procedures to be applied:  | Plant's staff will record data in accordance with monitoring plan.                          |
| Any comment:   | None  |

|  |  |
|--|--|
| <b>Data / Parameter:</b>   | P.5 NAP  |
| Data unit:   | tHNO <sub>3</sub>  |
| Description:   | Nitric acid (100% concentrated) over each project campaign   |
| Source of data to be used:   | Production log   |
| Value of data applied for the purpose of calculating expected emission reductions in section B.5 | To be determined during project campaigns  |
| Description of measurement methods and procedures to be applied:                                 | Projects will use either an electromagnetic or coriolis flow meter to measure mass flow of nitric acid. Density measurements will be carried out bu manually taking a sample and using a densimeter.<br>During the baseline campaign, all data values outside the CL <sub>normal</sub> will be excluded. |
| QA/QC procedures to be applied:  | The mass flow from the flow meter will be cross-checked with the sales invoices and other process data .<br>The flow meter is factory calibrated and will be subject to future local   |



|              |  |
|--------------|--|
|              | calibrations in accordance with the manufacturer's recommendations   |
| Any comment: | A new mass flow meter with density and built-in concentration measurements will be installed in the future. This will eliminate the need of manual sampling of product for density determination, improving the accuracy of the measurement. Therefore, the procedures will change slightly and will be reported accordingly in the monitoring report. |

|  |  |
|--|--|
| <b>Data / Parameter:</b>   | P.6 TSG  |
| Data unit:   | Degrees Centigrade (°C)  |
| Description:   | Temperature of stack gas   |
| Source of data to be used:   | Probe (part of gas volume flow meter)  |
| Value of data applied for the purpose of calculating expected emission reductions in section B.5 | Not applicable   |
| Description of measurement methods and procedures to be applied:                                 | The temperature measurement on the stack are required to normalise the volume flow (Nm <sup>3</sup> /h) in the stack and is not required to be reported as a separated parameter according to AM0034 VERSION 02.   |
| QA/QC procedures to be applied:  | The pressure cell will be installed as part of the main stack monitoring equipment. The flow meter is factory calibrated and will be subject to future local calibrations in accordance with the manufacturer's recommendations.. A reliable technical support infrastructure will be established. |
| Any comment:   |  |

|  |  |
|--|--|
| <b>Data / Parameter:</b>   | P.7 PSG  |
| Data unit:   | Pa   |
| Description:   | Pressure of stack gas  |
| Source of data to be used:   | Pressure cell as part of flow meter (part of gas volume flow meter)  |
| Value of data applied for the purpose of calculating expected emission reductions in section B.5 | Not applicable   |
| Description of measurement methods and procedures to be applied:                                 | The data will be recorded continuously (every second) and reported according to AM0034 VERSION 02.   |
| QA/QC procedures to be applied:  | The pressure cell will be installed as part of the main stack monitoring equipment. The flow meter is factory calibrated and will be subject to future local calibrations in accordance with the manufacturer's recommendations.. A reliable technical support infrastructure will be established. |



|              |  |
|--------------|--|
| Any comment: |  |
|--------------|--|

|  |   |
|--|---|
| <b>Data / Parameter:</b>   | P.8 EF <sub>n</sub>   |
| Data unit:   | tN <sub>2</sub> O/tH NO <sub>3</sub>  |
| Description:   | Emissions factor calculated for <i>n</i> th campaign  |
| Source of data to be used:   | Calculated from measured data (tons of nitric acid produced / tons of N <sub>2</sub> O emitted) |
| Value of data applied for the purpose of calculating expected emission reductions in section B.5 | To be calculated during the project campaigns   |
| Description of measurement methods and procedures to be applied:                                 | The data will be calculated and reported in accordance with AM0034 VERSION 02.                  |
| QA/QC procedures to be applied:  | Not applicable  |
| Any comment:   |   |

|  |   |
|--|---|
| <b>Data / Parameter:</b>   | P.9 EF <sub>ma, n</sub>   |
| Data unit:   | tN <sub>2</sub> O/tH NO <sub>3</sub>  |
| Description:   | Moving average emissions factor derived over time from campaign specific emission factors |
| Source of data to be used:   | Calculated from campaign emissions factors EF <sub>n</sub>                                |
| Value of data applied for the purpose of calculating expected emission reductions in section B.5 | To be calculated during the project campaigns   |
| Description of measurement methods and procedures to be applied:                                 | The data will be calculated and reported in accordance with AM0034 VERSION 02.            |
| QA/QC procedures to be applied:  | Not applicable  |
| Any comment:   | None  |

|  |  |
|--|--|
| <b>Data / Parameter:</b>                 | P.12 CL <sub>n</sub>   |
| Data unit:                               | tHNO <sub>3</sub>  |
| Description:                             | Campaign length of baseline campaign measured in metric tonnes of 100% concentrated nitric acid produced during the each project campaign. |
| Source of data to be used:               | Calculated from NAP  |
| Value of data applied for the purpose of | To be calculated during the project campaigns  |



|  |   |
|--|---|
| calculating expected emission reductions in section B.5          |   |
| Description of measurement methods and procedures to be applied: | To be calculated according to AM0034 VERSION 02 after the end of each campaign based on each and every tonne of nitric acid produce, regardless of whether the measured NCSG and VSG data were excluded from the relevant period. |
| QA/QC procedures to be applied:                                  | To be double-checked with sales invoices or other reliable document specifying this information.  |
| Any comment:   | None  |

|  |  |
|--|--|
| <b>Data / Parameter:</b>   | P.13 EF <sub>p</sub>   |
| Data unit:   | tN <sub>2</sub> O/tH NO <sub>3</sub>                                     |
| Description:   | Emissions factor used to determine emissions reductions                  |
| Source of data to be used:   | Calculated from campaign emissions factors                               |
| Value of data applied for the purpose of calculating expected emission reductions in section B.5 | To be calculated during the project campaigns                            |
| Description of measurement methods and procedures to be applied:                                 | The data will be calculated and reported according to AM0034 VERSION 02. |
| QA/QC procedures to be applied:  | Not applicable   |
| Any comment:   | None   |

|  |  |
|--|--|
| <b>Data / Parameter:</b>   | P.14 EF <sub>min</sub>   |
| Data unit:   | tN <sub>2</sub> O/tH NO <sub>3</sub>   |
| Description:   | Minimum emissions factor after 10 campaigns                                    |
| Source of data to be used:   | Determined from campaign emissions factors                                     |
| Value of data applied for the purpose of calculating expected emission reductions in section B.5 | To be calculated during the project campaigns                                  |
| Description of measurement methods and procedures to be applied:                                 | Determined after end of 10th campaign from campaign emission factors           |
| QA/QC procedures to be applied:  | Not applicable   |
| Any comment:   | None   |
| QA/QC procedures to  | Staff will conduct zero and span calibrations of the analyser according to the |



|              |   |
|--------------|---|
| be applied:  | monitoring plan.  |
| Any comment: | The data output from the analyser is processed using PC based windows software to produce reports and calculations from the raw data, providing corrections to oxygen, pressure and temperature and capable of producing averages and total emission figures as required. The algorithms used on the software are available to the DOE. |

**B.7.2 Description of the monitoring plan:**

&gt;&gt;

See Annex 4 for details

**B.8 Date of completion of the application of the baseline study and monitoring methodology and the name of the responsible person(s)/entity(ies)**

&gt;&gt;

**Data of completion:** 15<sup>th</sup> February 2007**Person/entity determining the baseline:**

Steve Abrams  
EcoSecurities  
40/41 Park End Street  
Oxford OX1 1JD  
United Kingdom  
Phone: +44 (0) 1865 202 635  
Fax: +44 (0) 1865 251 438

Details baseline and monitoring information are attached to Annex 3 and 4.

**SECTION C. Duration of the project activity / crediting period**
**C.1 Duration of the project activity:**
**C.1.1. Starting date of the project activity:**

&gt;&gt;14/09/2007

**C.1.2. Expected operational lifetime of the project activity:**

21 years

**C.2 Choice of the crediting period and related information:**
**C.2.1. Renewable crediting period**
**C.2.1.1. Starting date of the first crediting period:**

01/01/2008

**C.2.1.2. Length of the first crediting period:**

&gt;&gt;

7 (seven) years

**C.2.2. Fixed crediting period:****C.2.2.1. Starting date:**

&gt;&gt;

**C.2.2.2. Length:**

&gt;&gt;

**SECTION D. Environmental impacts**

&gt;&gt;

**D.1. Documentation on the analysis of the environmental impacts, including trans-boundary impacts:**

&gt;&gt;

The current Environmental Impact Assessment Law in China requires projects with insignificant environmental impact to be registered (a 30-page registration form is available). Since the environmental impacts of the proposed project are considered to be insignificant by the project participants or the host party, a registration form has been filled in and submitted to the local environmental protection bureau for approval<sup>15</sup>.

**D.2. If environmental impacts are considered significant by the project participants or the host Party, please provide conclusions and all references to support documentation of an environmental impact assessment undertaken in accordance with the procedures as required by the host Party:**

&gt;&gt;

This is not applicable because the environmental impacts are considered to be insignificant by the project participants or the host party.

**SECTION E. Stakeholders' comments**

&gt;&gt;

**E.1. Brief description how comments by local stakeholders have been invited and compiled:**

&gt;&gt;

The local stakeholder consultation process was carried out in conjunction with the Project Developer, which owns and operates the nitric acid plant involved in the project. The stakeholders identified and contacted are virtually identical with those for the Project Developer. The stakeholder consultation procedure was organized and conducted by EcoSecurities with assistance from the managers and selected staff at the site.

<sup>15</sup> The Environmental Impact Assessment Law in China, which was passed on October 28, 2002 and enforced since September 1, 2003, is available for download at [www.china-eia.com](http://www.china-eia.com) (its English website is under construction).



### **Local stakeholder consultation process**

The Project Developer was first briefed on the importance and options of the stakeholder consultation. Gathering comments through questionnaire was selected as the most acceptable method for the stakeholder consultation regarding the proposed project. In total 20 people were surveyed through the questionnaire. Most of these stakeholders are the employees of the company who are directly involved or affected by the proposed project. The list of the participants with the contact details can be found in table 2 below. The questionnaire is available for the DOE if required. The Project Developer also appointed a coordinator for the stakeholder consultation.





Table 1: List of stakeholders involved in the stakeholder consultation process

| Coordinator from Yunnan Jiehua Group Co. Ltd. for stakeholder consultation |          |  |   |   |                        |
|--|----------|--|---|---|------------------------|
| Name: Jiaxiang Zhang   |          |  |   |   |                        |
| Tel: 0871-7163380  |          |  |   |   |                        |
| Fax:0871-7164842   |          |  |   |   |                        |
| Address: Northwest Road Kaiyuan City Yunnan Province                       |          |  |   |   |                        |
| Email: jhawb@ynjh.cn   |          |  |   |   |                        |
| Local stakeholders involved in the stakeholder consultation process        |          |  |   |   |                        |
| Number   | Date     | Location                                   | Organization/department in the company (please specify direct or indirect involvement in the project) | Stakeholder, title (please specify whether anonymousness preferred) | tel/fax/address /email |
| 1  | 8/2/2007 |  | Jiehua Transportation Limited Company   | Director of the office  |                        |
| 2  | 8/2/2007 | Jiehua Transportation Limited Company      | Jiehua Transportation Limited Company   | Security Guard  | 13887354070            |
| 3  |          |  |   | Anonym  | 7163419                |
| 4  | 8/2/2007 | The main control room of nitric acid plant | Direct  | worker  | 0873-7163709/7163752   |
| 5  |          |  | Direct  | Anonym  |                        |
| 6  | 9/2/2007 | Office of nitric acid plant                | Direct  | worker  | 0873-7163753           |
| 7  | 9/2/2007 | Office of nitric acid plant                | Direct  | worker  | 0873-7163709           |
| 8  |          |  | Indirect  | Anonym  |                        |
| 9  | 8/2/2007 | Kaiyuan City Yunnan Province               | Direct  | worker  | 0873-7163480           |
| 10   | 8/2/2007 | The main control room of nitric acid plant | Direct  | worker  | 0873-7163709           |
| 11   | 9/2/2007 | Jiehua Group                               | Direct  | worker  | 0873-7163709           |
| 12   | 8/2/2007 |  | Asset management Co.  | Leader/Anonym   |                        |
| 13   | 8/2/2007 |  | Asset management Co.  | Worker/Anonym   |                        |
| 14   |          |  | Nitric acid chemical plant Direct   | Person in charge/Anonym   |                        |
| 15   |          |  | Nitric acid chemical plant Direct   | Worker/Anonym   |                        |
| 16   |          |  | Nitric acid chemical plant Direct   | Worker/Anonym   |                        |



## CDM – Executive Board

page 42

|    |          |              |                                   |                         |              |
|----|----------|--------------|-----------------------------------|-------------------------|--------------|
| 17 |          |              | Nitric acid chemical plant Direct | Person in charge/Anonym |              |
| 18 | 8/2/2007 | Kaiyuan City | Nitric acid chemical plant Direct | Person in charge        | 0873-7163251 |
| 19 | 8/2/2007 | Kaiyuan City | Heat power plant                  | electrician             |              |
| 20 | 8/2/2007 | Kaiyuan City | 8/2/2007                          | Boiler worker           |              |

**E.2. Summary of the comments received:**

&gt;&gt; Table 2: Results from the stakeholders consultation

| Number given to the stakeholder | Environmental impact (positive, neutral or negative) | Employ opportunities (positive, neutral or negative) | Development of local economy (positive, neutral or negative) | Social aspects of local communities (positive, neutral or negative) | You and your family (positive, neutral or negative) | Overall (positive, neutral or negative) | Specific remarks |
|---------------------------------|--|--|--|---|---|---|------------------|
| 1                               | Positive   | Positive   | Positive   | Positive  | Neutral   | Positive                                | None             |
| 2                               | Positive   | Positive   | Positive   | Positive  | Neutral   | Positive                                | None             |
| 3                               | Positive   | Neutral  | Positive   | Positive  | Positive  | Positive                                | None             |
| 4                               | Positive   | Neutral  | Neutral  | Neutral   | Neutral   | Positive                                | None             |
| 5                               | Positive   | Neutral  | Positive   | Positive  | Neutral   | Positive                                | None             |
| 6                               | Positive   | Positive   | Positive   | Neutral   | Neutral   | Positive                                | None             |
| 7                               | Positive   | Positive   | Positive   | Positive  | Neutral   | Positive                                | None             |
| 8                               | Positive   | Neutral  | Positive   | Positive  | Neutral   | Positive                                | None             |
| 9                               | Positive   | Neutral  | Positive   | Neutral   | Neutral   | Positive                                | None             |
| 10                              | Positive   | Neutral  | Positive   | Positive  | Neutral   | Positive                                | None             |
| 11                              | Positive   | Positive   | Positive   | Positive  | Positive  | Positive                                | None             |
| 12                              | Positive   | Neutral  | Neutral  | Positive  | Neutral   | Positive                                | None             |
| 13                              | Positive   | Neutral  | Neutral  | Neutral   | Neutral   | Positive                                | None             |
| 14                              | Positive   | Positive   | Positive   | Positive  | Neutral   | Positive                                | None             |
| 15                              | Positive   | Positive   | Positive   | Positive  | Positive  | Positive                                | None             |
| 16                              | Positive   | Positive   | Positive   | Positive  | Neutral   | Positive                                | None             |
| 17                              | Positive   | Neutral  | Positive   | Neutral   | Neutral   | Positive                                | None             |
| 18                              | Positive   | Neutral  | Neutral  | Positive  | Neutral   | Positive                                | None             |
| 19                              | Positive   | Positive   | Positive   | Positive  | Neutral   | Positive                                | None             |
| 20                              | Positive   | Positive   | Positive   | Positive  | Positive  | Positive                                | None             |
| Total                           | 100% positive  | 50% positive; 50% neutral                            | 80% positive; 20% neutral                                    | 87% positive, 13% neutral   | 20% positive, 80% neutral                           | 100% positive                           | None             |



The overall results of the stakeholder consultation show that the project has a positive social and environmental impact.

**E.3. Report on how due account was taken of any comments received:**

>>

Since the overall comments on the project are positive, no action or any changes to the project will have to be considered in the implementation of the proposed project activity.

Annex 1**CONTACT INFORMATION ON PARTICIPANTS IN THE PROJECT ACTIVITY**

|                  |                       |
|------------------|-----------------------|
| Organization:    | Yunan Jiehua Group    |
| Street/P.O.Box:  | Xibei Road            |
| Building:        | -                     |
| City:            | Kaiyuan city          |
| State/Region:    | Yunan                 |
| Postfix/ZIP:     | 661600                |
| Country:         | P.R. China            |
| Telephone:       | Tel: +86 873 7163199  |
| FAX:             | Fax : +86 873 7164842 |
| E-Mail:          |                       |
| URL:             |                       |
| Represented by:  |                       |
| Title:           | General Manager       |
| Salutation:      | Mr                    |
| Last Name:       | Zhu Tingqi            |
| Middle Name:     |                       |
| First Name:      |                       |
| Department:      |                       |
| Mobile:          |                       |
| Direct FAX:      | Fax : +86 873 7164842 |
| Direct tel:      | Tel: +86 873 7163199  |
| Personal E-Mail: |                       |

**Project Annex 1 sponsor and Carbon advisor:**

|                  |  |
|------------------|--|
| Organization:    | EcoSecurities Group PLC.   |
| Street/P.O.Box:  | 40 Dawson Street   |
| Building:        | -  |
| City:            | Dublin   |
| State/Region:    | -  |
| Postfix/ZIP:     |  |
| Country:         | Ireland  |
| Telephone:       | +353 1613 9814   |
| FAX:             | +353 1672 4716   |
| E-Mail:          | <a href="mailto:cdm@ecosecurities.com">cdm@ecosecurities.com</a> |
| URL:             | <a href="http://www.ecosecurities.com">www.ecosecurities.com</a> |
| Represented by:  |  |
| Title:           | Director   |
| Salutation:      | Dr.  |
| Last Name:       | Moura Costa  |
| Middle Name:     | -  |
| First Name:      | Pedro  |
| Department:      | -  |
| Mobile:          |  |
| Direct FAX:      |  |
| Direct tel:      |  |
| Personal E-Mail: |  |



Annex 2

**INFORMATION REGARDING PUBLIC FUNDING**

The project will not receive any public funding.

**Annex 3****BASELINE INFORMATION (detailed data from monitoring to be provided)**

| Parameter            | unit                              | Description   | Value |
|----------------------|-----------------------------------|---|-------|
| OT <sub>normal</sub> | Degrees Centigrade (°C)           | Normal operating temperature  | 880   |
| OP <sub>normal</sub> | Bar                               | Normal operating pressure   | 6.6   |
| AFR                  | NM3 NH3/h                         | Ammonia gas flow rate to the Ammonia Oxidation Reactor (AOR)                      | 4100  |
| AIFR                 | % v/v of NH3 in air               | ammonia to air ratio into the AOR   | 10    |
| NCSG                 | mgN <sub>2</sub> O/m <sup>3</sup> | Mean concentration of N <sub>2</sub> O in the stack gas for the baseline campaign | 2940  |
| VSG                  | Nm3/h                             | Mean stack gas volume flow rate for the baseline campaign                         | 20000 |



#### Annex 4

### MONITORING INFORMATION

The project will apply an advanced continuous emissions measurement (CEM) system that meets the requirement of the methodology AM0034 VERSION 02 to monitor the N<sub>2</sub>O concentration as well as the gas flow volume in the stack.

This monitoring plan details the steps taken to monitor on a regular basis the GHG emissions reductions from the Yunan Jiehua N<sub>2</sub>O Abatement Project in China. The main components covered within the monitoring plan are:

1. Parameters to be monitored, and how the data will be collected and stored
2. The equipment to be used in order to carry out monitoring by using BS EN14181:2004 Stationary Source Emissions
3. Operational procedures and quality assurance responsibilities
4. Operational management structure

The requirements of this monitoring plan are in line with the kind of information routinely collected by companies managing “Catalytic reduction of N<sub>2</sub>O inside the ammonia burner of nitric acid plants” N<sub>2</sub>O abatement projects, so internalising the procedures will be simple and straightforward. When necessary, the monitoring plan will be updated and adjusted to meet operational requirements, provided that such modifications are approved by a Designated Operational Entity during the process of verification.

According to the approved monitoring methodology of AM0034 VERSION 02 “Catalytic reduction of N<sub>2</sub>O inside the ammonia burner of nitric acid plants”, the monitoring system will cover the baseline emission and project emission. Monitoring for Yunan Jiehua N<sub>2</sub>O Abatement Project will start with the baseline monitoring. The monitoring plan details the actions necessary to record all the variables and factors required by the methodology AM0034 VERSION 02, as provided in section B 7.1 of the PDD. All data will be archived electronically or in hard copy in line with AM0034 VERSION 02, and data will be kept for the full crediting period and two years after.

#### **1. Parameters monitoring**

Parameters which need to be monitored during the baseline and project implementation are shown in Table 4a-4b, including the requirements of record frequency and archive.

In line with the monitoring methodology AM0034 VERSION 02, the project will apply the above-mentioned CEM system to acquire data relating to the calculation of emissions reductions achieved by the project.



Table 4a: Project emission parameters

| ID number | Data variable   | Source of data                        | Data unit   | Measured (m), calculated (c) or estimated (e) | Recording frequency                 | Proportion of data to be monitored | How will the data be archived? (electronic/ paper) | Comments  |
|-----------|---|---------------------------------------|---|---|-------------------------------------|------------------------------------|--|---|
| P. 1      | NCSG<br><br>N <sub>2</sub> O concentration in the stack gas               | N <sub>2</sub> O analyser             | mgN <sub>2</sub> O/m <sup>3</sup> (converted from ppm if necessary) | m   | Every 2 seconds                     | 100%                               | Electronic and paper for at least 2 years          | The data output from the analyser will be processed using appropriate software program  |
| P. 2      | VSG<br><br>Volume flow rate of the stack gas                              | Gas volume flow meter                 | m <sup>3</sup> /h   | m   | Every 2 seconds                     | 100%                               | Electronic and paper for at least 2 years          | The data output from the stack flow meter will be processed using appropriate software. |
| P. 3      | PE <sub>n</sub><br><br>N <sub>2</sub> O emissions of nth project campaign | Calculation from measured data        | tN <sub>2</sub> O   | c   | At least once after each campaign   | 100%                               | Electronic and paper for at least 2 years          |   |
| P. 4      | OH<br><br>Operating hours   | Production log                        | Hours   | m   | Daily, compiled for entire campaign | 100%                               | Electronic and paper for at least 2 years          | Plant manager records the hours of full operation of the plant during a campaign        |
| P. 5      | NAP<br><br>Nitric Acid production (100% concentrate)                      | Production log                        | tHNO <sub>3</sub>   | m   | Daily, compiled for entire campaign | 100%                               | Electronic and paper for at least 2 years          | Total production over project campaign.   |
| P. 6      | TSG<br><br>Temperature of stack gas                                       | Probe (part of gas volume flow meter) | °C  | m   | Every 2 seconds                     | 100%                               | Electronic and paper for at least 2 years          |   |





|      |  |   |                                     |   |                            |      |   |   |
|------|--|---|-------------------------------------|---|----------------------------|------|---|---|
|      |  |   |                                     |   |                            |      |   |   |
| P. 7 | PSG<br>Pressure of stack gas   | Probe (part of gas volume flow meter)       | Pa                                  | m | Every 2 seconds            | 100% | Electronic and paper for at least 2 years |   |
| P. 8 | EF <sub>n</sub><br>Emissions factor calculated for <i>n</i> th campaign    | Calculated from measured data               | tN <sub>2</sub> O/tHNO <sub>3</sub> | c | After end of each campaign |      |   |   |
| P. 9 | EF <sub>mn,a</sub><br>Moving average emissions factor                      | Calculated from campaign emissions factors  | tN <sub>2</sub> O/tHNO <sub>3</sub> | c | After end of each campaign |      |   | For the first campaign EF and EF <sub>x</sub> will be equal |
| P.10 | CL <sub>n</sub><br>Campaign length   | Calculated from nitric acid production data | tHNO <sub>3</sub>                   | c | After end of each campaign | 100% | Electronic and paper for at least 2 years |   |
| P.11 | EF <sub>p</sub><br>Emissions factor used to determine emissions reductions | Determined from campaign emissions factors  | tN <sub>2</sub> O/tHNO <sub>3</sub> | c | After end of each campaign |      |   | Determined from campaign emissions factors                  |
| P.12 | EF <sub>min</sub><br>Minimum emissions factor after 10 campaigns           | Determined from campaign emissions factors  | tN <sub>2</sub> O/tHNO <sub>3</sub> | c | After end of 10th campaign |      |   | Determined from campaign emissions factors                  |



Table 4b: Baseline emission parameters

| ID number | Data variable   | Source of data                        | Data unit  | Measured (m), calculated (c) or estimated (e) | Recording frequency                   | Proportion of data to be monitored | How will the data be archived? (electronic/ paper)   | Comments  |
|-----------|---|---------------------------------------|--|---|---------------------------------------|------------------------------------|--|---|
| B. 1      | NCSG <sub>BC</sub><br><br>N <sub>2</sub> O concentration in the stack gas       | N <sub>2</sub> O analyser             | mgN <sub>2</sub> O/<br>m <sup>3</sup><br>(converted from ppm if necessary) | m   | Every seconds 2                       | 100%                               | Electronic and paper for the entire crediting period | The data output from the analyser will be processed using appropriate software.         |
| B. 2      | VSG <sub>BC</sub><br><br>Volume flow rate of the stack gas                      | Gas volume flow meter                 | m <sup>3</sup> /h  | m   | Every seconds 2                       | 100%                               | Electronic and paper for the entire crediting period | The data output from the stack flow meter will be processed using appropriate software. |
| B. 3      | BE <sub>BC</sub><br><br>Total N <sub>2</sub> O for baseline campaign            | Calculation from measured data        | tN <sub>2</sub> O  | c   | At least once after baseline campaign | 100%                               | Electronic and paper for the entire crediting period |   |
| B. 4      | OH <sub>BC</sub><br><br>Operating hours   | Production log                        | hours  | m   | Daily, compiled for entire campaign   | 100%                               | Electronic and paper for the entire crediting period | Plant manager records the hours of full operation of the plant during a campaign.       |
| B. 5      | NAP <sub>BC</sub><br><br>Nitric acid (100% concentrated) over baseline campaign | Production log                        | tHNO <sub>3</sub>  | m   | Daily, compiled for entire campaign   | 100%                               | Electronic and paper for the entire crediting period |   |
| B. 6      | TSG<br><br>Temperature of stack gas   | Probe (part of gas volume flow meter) | °C   | m   | Every seconds 2                       | 100%                               | Electronic and paper for the entire crediting period |   |
| B. 7.     | PSG<br><br>Pressure of stack  | Probe (part of gas volume flow meter) |  | m   | Every seconds 2                       | 100%                               | Electronic and paper for the entire crediting period |   |



|      |   |   |   |    |  |      |  |  |
|------|---|---|---|----|--|------|--|--|
|      | gas   |   |   |    |  |      |  |  |
| B. 8 | EF <sub>BL</sub><br>Emissions factor for baseline period        | Calculated from measured data   | tN <sub>2</sub> O/<br>tHNO <sub>3</sub> | c  | At the end of the baseline campaign          |      | Electronic and paper for the entire crediting period |  |
| B. 9 | UNC<br>Overall measurement uncertainty of the monitoring system | Calculation of the combined uncertainty of the applied monitoring equipment | %                                       | c  | Once after monitoring system is commissioned |      | Electronic and paper for the duration of the project |  |
| B.10 | AFR<br>Ammonia gas flow rate to the AOR                         | Monitored   | kgNH <sub>3</sub> /h                    | m  | Continuously                                 | 100% | Electronic and paper for at least 2 years            | To be obtained from the operating condition campaign                       |
| B.11 | AFR <sub>max</sub><br>Maximum ammonia flow rate                 | Plant records   | kgNH <sub>3</sub> /h                    | m  | Once   | 100% | Electronic and paper for at least 2 years            |  |
| B.12 | AIFR<br>Ammonia to Air ratio                                    | Monitored   | m <sup>3</sup> /h                       | mc | Every hour                                   | 100% | Electronic and paper for at least 2 years            | To be obtained from the operating condition campaign                       |
| B.13 | CL <sub>BL</sub><br>Campaign length of baseline campaign        | Calculated from nitric acid production data                                 | tHNO <sub>3</sub>                       | c  | After end of each campaign                   | 100% | Electronic and paper for at least 2 years            |  |
| B.14 | CL <sub>normal</sub><br>Normal campaign length                  | Calculated from nitric acid production data                                 | tHNO <sub>3</sub>                       | c  | Prior to end of baseline campaign            |      |  | Average historical campaign length during the operation condition campaign |



|      |   |            |                   |    |               |      |   |  |
|------|---|------------|-------------------|----|---------------|------|---|--|
| B.15 | AIFR <sub>max</sub><br>Maximum ammonia to air ratio                                   | Calculated | m <sup>3</sup> /h | mc | Once          | 100% | Electronic and paper for at least 2 years |  |
| B.16 | OT <sub>h</sub><br>Oxidation temperature for each hour                                | Monitored  | °C                | m  | Every hour    | 100% | Electronic and paper for at least 2 years | To be obtained from the operating condition campaign   |
| B.17 | OT <sub>normal</sub><br>Normal operating temperature                                  | Monitored  | °C                | m  | Once          | 100% | Electronic and paper for at least 2 years |  |
| B.18 | OP <sub>h</sub><br>Oxidation Pressure for each hour                                   | Monitored  | Pa                | m  | Every hour    | 100% | Electronic and paper for at least 2 years | To be obtained from the operating condition campaign   |
| B.19 | OP <sub>normal</sub><br>Normal operating pressure                                     | Monitored  | Pa                | m  | Once          | 100% | Electronic and paper for at least 2 years |  |
| B.20 | GS <sub>normal</sub> ,<br>Normal gauze supplier for the operation condition campaigns | Monitored  |                   | m  | Each campaign | 100% | For project crediting period              | To be obtained during the operating condition campaign |
| B.21 | GS <sub>BL</sub><br>Gauze supplier for baseline campaign                              | Monitored  |                   | m  | Once          | 100% | For project crediting period              | To be obtained during the baseline campaign            |
| B.22 | GS <sub>project</sub><br>Gauze supplier for the project campaigns                     | Monitored  |                   | m  | Each campaign | 100% | For project crediting period              | To be obtained during the project campaign             |



|      |  |           |  |   |               |      |                              |  |
|------|--|-----------|--|---|---------------|------|------------------------------|--|
| B.23 | GC <sub>normal</sub><br>Gauze composition during the operation campaign.     | Monitored |  | m | Each campaign | 100% | For project crediting period | To be obtained during the operating condition campaign |
| B.24 | GC <sub>BL</sub><br>Gauze composition during baseline campaign               | Monitored |  | m | Once          | 100% | For project crediting period | To be obtained during the baseline campaign            |
| B.25 | GC <sub>project</sub><br>Gauze composition during project campaign           | Monitored |  | m | Each campaign | 100% | For project crediting period | To be obtained during the project campaign             |
| B.26 | EF <sub>reg</sub><br>Emissions level set by incoming policies or regulations |           |  |   |               |      |                              |  |



**2. The monitoring equipment**

The equipment to be used in order to carry out the monitoring will comply with European Norm EN14181: Quality assurance of automated measuring systems, 2004. Table 2a lists the equipments involved in the monitoring system.

Table 2a. Monitoring equipments for the Yunan Jiehua N2O Abatement Project.

**N<sub>2</sub>O Monitoring System - Equipment Details**

**JieHua**

**MGA 3000**

|                                |                        |
|--------------------------------|------------------------|
| ADC model number               | MGA3000                |
| Serial number                  | 4153                   |
| Equipment type                 | Infra-red gas analyser |
| Gas 1 (range) N <sub>2</sub> O | 3000ppm                |
| Gas 2 (range) NO               | 5000ppm                |
| Gas 3 (range) O <sub>2</sub>   | 25.00%                 |
| Mositure trap                  | Included               |
| Additional filtration          | Included               |
| Chinese manual provided        |                        |
| EN14181 QAL1 detail received   |                        |
| List of spares supplied        | Filter                 |

**BuNox**

|                            |                          |
|----------------------------|--------------------------|
| Bhuller model number       | BuNox                    |
| Serial number              | A663968/001-004 55300099 |
| Equipment type             | GAS-Konverter(NO2-NO)    |
| Calibrated range (NO conv) | x                        |
| Chinese manual provided    |                          |
| List of spares supplied    | catalyst cartridge       |

**PermaPure MiniGass**

|                               |                |
|-------------------------------|----------------|
| PermaPure model number        | MG-1228-S1-P20 |
| Serial number                 | MG12150603     |
| Flow range                    | 0-20l/min      |
| Flange provided by EcoSec/ADC | Yes            |
| Chinese manual provided       |                |

**Systec flow meter**

|                                       |  |
|---------------------------------------|--|
| Systec model number                   | DF25LF/M23   |
| Serial number                         | 10562-01   |
| Equipment type                        | Differential pressure averaging pitot tube and DP cell |
| Calibrated range (Nm <sup>3</sup> /h) | 36000Nm <sup>3</sup> /h                                |
| Flange provided by EcoSec/ADC         | Yes  |



|                         |  |
|-------------------------|--|
| Chinese manual provided |  |
|-------------------------|--|

**Moisture**

|                                       |                       |
|---------------------------------------|-----------------------|
| Systec model number                   | gesis1200 703-691     |
| Serial number                         | 126715 63             |
| Equipment type                        | GENESIS Oxygen system |
| Calibrated range (Nm <sup>3</sup> /h) | 0-25% v/w             |
| Flange provided by EcoSec/ADC         | Yes                   |
| Chinese manual provided               |                       |

**PC**

|                    |                          |
|--------------------|--------------------------|
| PC model           | lenovo                   |
| Serial number      | ES01739370               |
| Equipment type     | Basic desk top PC        |
| Dongle included    | Yes                      |
| Software installed | PC AnyWhere and CEMSuite |
|                    |                          |
|                    |                          |
|                    |                          |

**Calibration gas**





|                     |   |
|---------------------|---|
| Zero gas            | N2 8L 9.0Mpa 99.999% mol/mol                |
| N2O and O2 span gas | N2O 8L 9.0Mpa 2008*10 <sup>-6</sup> mol/mol |
| NO span gas         | NO 8L 9.0Mpa 5075*10 <sup>-6</sup> mol/mol  |
| O2 gas              | O2 8L 9.0Mpa 1.98%                          |

**Mass flow meter**

|                         |                                 |
|-------------------------|---------------------------------|
| Make                    | SHANGHAI KROHNE                 |
| Model                   | MFM1081K-600-EX                 |
| Serial number           | 640762 0610-358                 |
| Equipment type          | Electromagnetic mass flow meter |
| Equipment description   |                                 |
| Chinese manual provided | Yes                             |
| Calibrated range        | 30 t/h                          |

**Data Logger**

|                       |                   |
|-----------------------|-------------------|
| Make                  | ADC               |
| Model                 | DSU-sw 072        |
| Serial number         | 128.0.0.2         |
| Equipment type        | DSU               |
| Equipment description | Data Storage Unit |



### 3. Operational procedures and quality assurance responsibilities

In order to maintain high quality on the monitored data, quality assurance and quality control measures are to be operated. This will ensure that the generated data are complete, transparent and reliable.

In particular, the installation, calibration and operation of the AMS will follow the requirements specified by AM0034 VERSION 02. This includes:

- a. Selection of the location of measurement
- b. Duly installation of the monitoring equipment
- c. Correct choice of measurement range
- d. Calibration of the AMS using the Standard Reference Method (SRM) as guidance
- e. Calibration curve either as linear regression or as straight line from absolute zero to centre of a scatter-plot
- f. Calculation of the standard deviation at the 95% confidence interval
- g. Inspection every three years.

The project operator will apply a high standard continuous quality assurance on the AMS, following the guidance provided by AM0034 VERSION 02:

- a. Permanent quality assurance during the plant operation
- b. Assurance of reliable and correct operation of the monitoring equipment
- c. Regular controls will be applied to ensure that zero point, span, and drift meet the schedule of manufacturer maintenance intervals.

Annual functionality test will be conducted and this will include SRM measurements to check for uncertainties in the data measured by the AMS.

- a. Annual confirmation of the calibration curve
- b. Validity proof of calibration curves
- c. Back-setting of excess meter of invalid calibration range

The calibration and maintenance of the AMS will follow the instructions prescribed in EN14181.

**Downtime of automated measuring system:** According to the monitoring methodology AM0034 VERSION 02, in the event that the monitoring system is down, the lowest between the conservative IPCC (4.5 kg N<sub>2</sub>O/ton nitric acid) or the last measured value will be valid and applied for the downtime period for the baseline emissions factor, and the highest measured value in the campaign will be applied for the downtime period for the campaign emission factor.

### 4. Operational management structure

The project has set up an operational management to oversee and run the monitoring system. Staff members and contractors involved in the monitoring have received necessary monitoring training and test to ensure that they have sufficient knowledge. Regular training will be provided in order to help the staffs to satisfactorily meet their monitoring obligations. The authority and responsibility for project management, monitoring, measurement and reporting will be agreed between the project participants and formalized.

Procedures for calibration of monitoring equipment, maintenance of monitoring equipment and installations, and for records handling have been established and kept at the site.

An organisation chart is provided for the project in Figure 4.



Figure 4. Organisation chart for the Yunan Jiehua N2O Abatement Project.

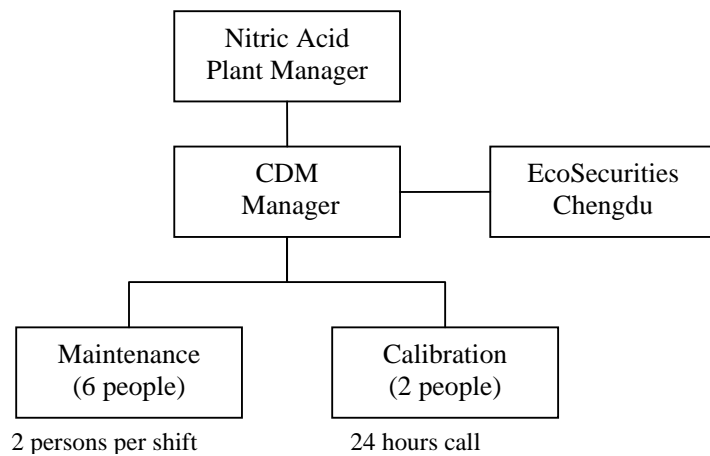

-----